

# Katalog 2019

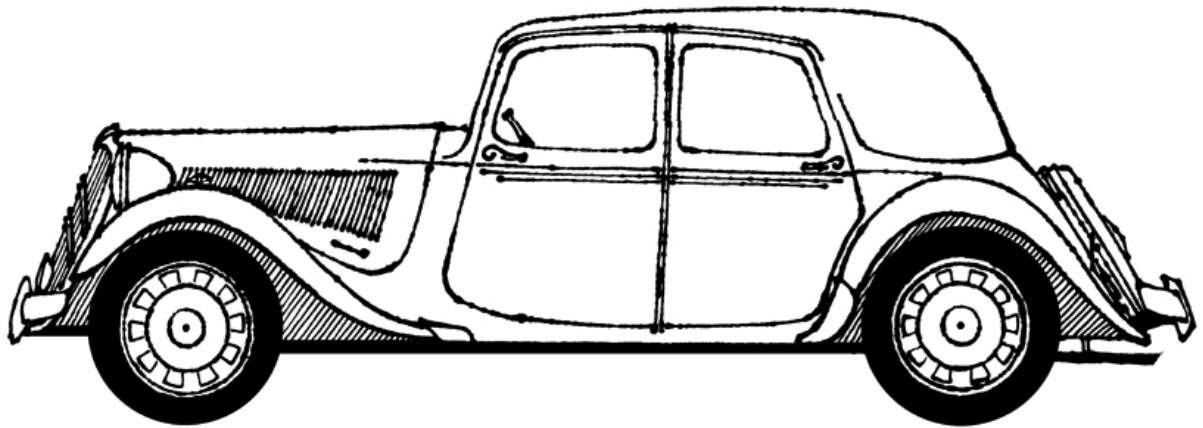

## Traction 11 CV

Preisstand September 2018

Les prix actuels  
peuvent être  
trouvés à

[www.traction-avant.ch](http://www.traction-avant.ch)

**ETS Ersatzteilservice AG**

Usterstrasse 65 Telefon 044 802 80 55  
8600 Dübendorf Fax 044 802 80 56

doeschwo@2cv-ersatzteile.ch

<b>Inhaltsverzeichnis</b>	<b>Seite / Page</b>	<b>Sommaire</b>
Motorblock	3	Piece Moteur
Kurbelwelle / Kolben / Büchsen	5	Vilebre / Quin / Pistons
Nockenwelle	7	Arbre a cames et ses commandes
Zylinderkopf	8	Culasse tubulures culbuteurs
Getriebegehäuse	13	Boite de vitesses carter
Zahnräder	14	Pignons arbr
Differenzial	17	Differentiel
Schaltgestänge	18	Commande des vitesses
Oelpumpe	19	Pompe a huile
Wasserkühlung / Kühlergrill	21	Radiateur
Wasserpumpe / Ventilator	23	Pompe a eau ventilateur
Kupplung	25	Embrayage
Vergaser / Luftfilter	27	Carburateur filtre air
Zündverteiler / Zündungsteile	29	Allumage
Auspuffanlage	34	Echappement
Motor und Getriebe / Aufhängung	35	Suspension Moteur
Benzinpumpe	36	Pompes essence
Benzintank	38	Reservoir essence
Vorderachse	41	Train avant
Hinterachse komplett	44	Essieu arriere
Antriebswellen	46	Transmissions et fusees
Lenkung	48	Direction
Stossdämpfer hinten	51	Amortisseure AR
Bremstrommel / Lager vorne	52	Tembours AV et roulements
Bremsen	53	Freinage
Bremstrommel hinten	58	Tambours AR et roulements
Handbremse	59	Frein a main
Pedale	60	Pedalier
Anlasser	62	Demarreur
Lichtmaschine	65	Dynamo
Scheibenwischer	67	Essuie – Glace
Tachometer	68	Tableau lumineux
Elektrische Ausrüstung	69	Electricite divers
Kotflügel vorne	72	Ailes avant
Carrosserie	73	Carrosserie divers
Motorhaube Vorderbau	75	Avant de caisse capot
Kofferdeckel	77	Porte de coffre AR et malle AR
Türen	80	Porte
Stossstangen	84	Pare – Chocs
Heizung	86	Chauffage a air
Armaturen / Lüfterklappe	87	Auvant
Frontscheibe / Rahmen	89	Pare brise
Scheiben	90	Glace
Scheinwerfer	91	Optique
Blinker / Rücklichter	92	Feux / AR indicateurs feu lanterale
Birnen 6 V	95	Ampoule 6 V
Birnen 12 V	96	Ampoule 12 V
Räder	98	Pneu
Sitzgestell	99	Sieges
Innenausstattung	100	Interieur tissu
Zubehör Chromteile	104	Accessoires chrome
Werkzeug	105	Outils
Verbrauchsmaterial	106	Sieges
Allgemeine Geschäftsbedingungen	108	Condition de vente

**PIECE MOTEUR**

No d'article	article		Prix CHF
117290	BOUCHON DE VIDANGE EAU MOTEUR	M12x22x20mm	8.30
232	JEU DE JOINTS MOTEUR 11CV PERFO 11 D	79 Teile	259.00
6.02360	JOINT CUIVRE 16 x 24		0.40
2470-S	JOINT METALL. BOUCHON VID EAU	12x17x2	1.20
451335	POCHETTE JOINT DE CARTER	488x20mm	25.00
451374	JOINT COUVERCLE DISTRIBUTION	-	6.70
451378	GOUJON CHAPEAUX PALIERS	12x77mm	3.10
451762	JOINT COUVERCLE DISTRIBUTION	-	5.20
451835	ARRETOIR SIMPLE CHAP. PALIERS	-	4.10
452367E	RONDELLE EXP CARTER		2.20
452392	TOLE ETANCHEITE CHAPEAU PALIER	8x0,5mm	9.20
457352E	JOINT ETANCHEITE VILEBREQUIN	50mm	179.00
457352K	ANNEAU GRAPHITE JOINT 457352E	8x9mm	28.20
461179	PIED DE DISTRIBUTION		77.00
470424	JOINT DU TUBE AERATION	80x59mm	2.30
730007	PIED DE CENTRAGE DE CULA SSE	16x7,5mm	6.00
6.02355	BOUCHON VID CARTER INF MAGN	31x150	14.00
830	JOINT BOUCHON VIDANGE CARTER	Ø32x38x2mm	2.50
88688	ARRETOIR DBLE CHAPEAUX PALIERS	120x24mm	4.20
A132-1M	BOUCHON VID CARTER INF MAGN	M16x1,5x20	8.00
D111-3A	JOINT BASE CYLINDRE 0.07MM	4 stk/pc	2.00
D111-3B	JOINT BASE CYLINDRE 0.2MM	4 stk/pc	2.10
D111-3D	JOINT BASE CYLINDRE 0.25MM	2 stk/pc	16.60

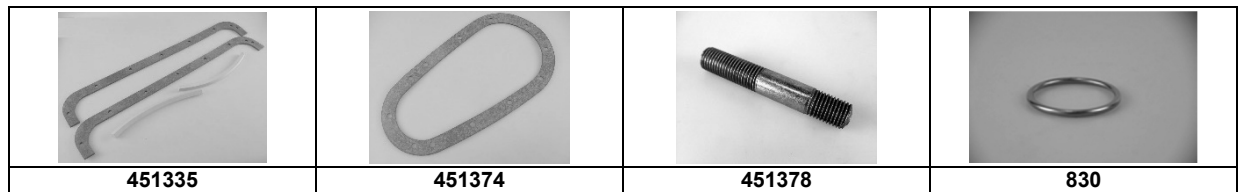

830

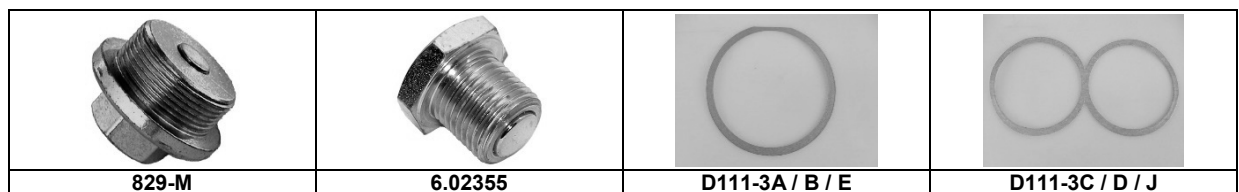
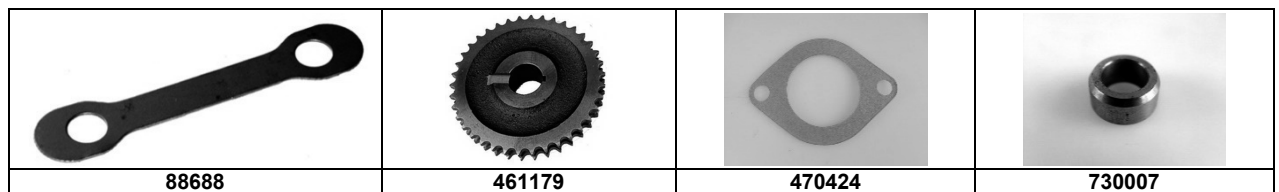
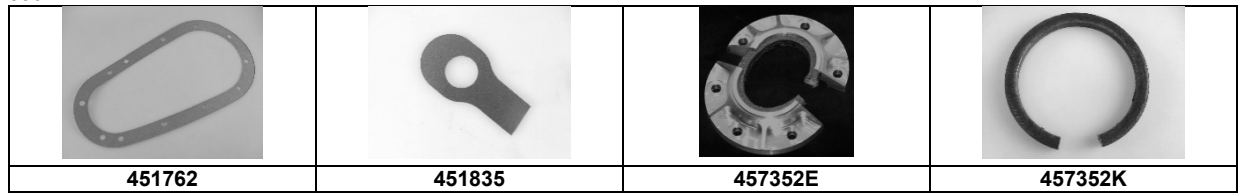



## VILEBREQUIN PISTONS

No d'article	article		Prix CHF
45130A	COUSSINET DE PALIER STD.	3x2 50,00mm	640.00
45130B	COUSSINET DE PALIER 0.25	3x2 49,75mm	640.00
45130C	COUSSINET DE PALIER 0.5	3x2 49,50mm	640.00
45130D	COUSSINET DE PALIER 0.75	3x2 49,25mm	640.00
45130E	COUSSINET DE PALIER 1.00	3x2 49.00mm	640.00
453038	VIS VOLANT	8x24x11	11.30
456623	ARRETOIR SIMPLE BOULON BIELLE		1.80
457016	PLAQUE ARRET VOLANT MOTEUR	107x4mm	11.50
460638	BAGUE DE PIED DE BIELLE	24,15x20	17.20
460644	SEGMENT ARRET AXE DE PISTON		1.80
461125A	ROND. REGL VILEBREQ 38X50X0.1	-	5.40
461125B	ROND. REGL VILEBREQ 38X50X0.25	-	5.40
461125C	ROND. REGL VILEBREQ 38X50X0.5	-	7.40
461126	RONDELLE BUTEE DU VILEBREQUIN	38x65x5	19.80
461258	COURONNE DE DEMARREUR	Ø265mm 93t	153.40
461494	ECROU DE PIGNON DE VILEBREQUIN	M36x150 sw 46 20k	12.30
461495	ARRETOIR ECROU DE VILEBREQUIN	36,5mm	5.80
88105	CLAVETTE VILEBR/ARBRE A GAMES	4,8mm	2.40
88148	ECROU VOLANT MOTEUR	M8x125x7	3.00
88667	ARRETOIR DOUBLE MASSELOTES	40mm	5.20
89500	ROULEMENT AV DE VILEBREQUIN	17x40x12mm	16.00
D111-02	CHEMISES ET PISTONS	Ø78mm	480.00
D111-10	SEGMENT DE PISTON ETANG. 2MM	Ø78x2mm	12.80
D111-10A	SEGMENT DE PISTON ETANG. 2.5MM	Ø78x2,5mm	12.10
D111-10B	SEGMENT DE PISTON ETANG. 3MM	Ø78x3mm	11.90
D111-11	SEGMENT DE PISTON RACLEUR 4MM	Ø78x4mm	18.90
D111-11A	SEGMENT DE PISTON RACL. 4.5MM	Ø78x4,5mm	18.00
D111-11B	SEGMENT DE PISTON RACLEUR 5MM	Ø78x5mm	18.90

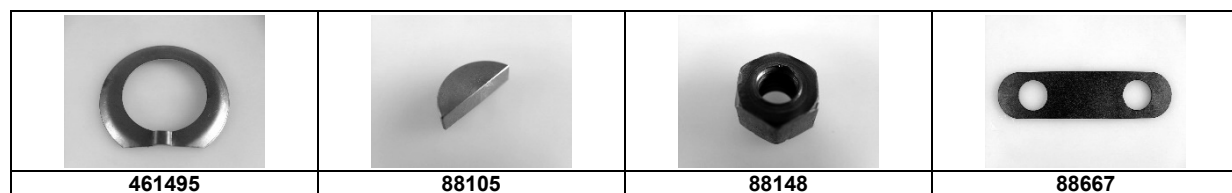
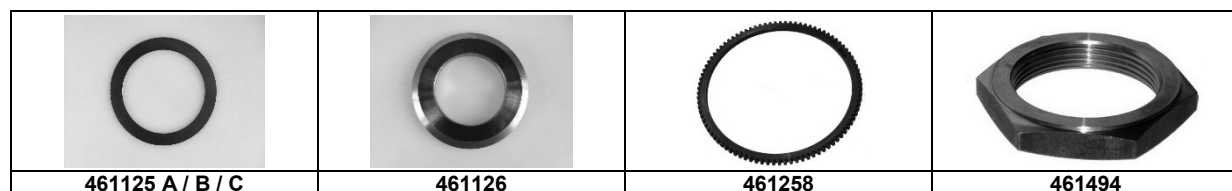
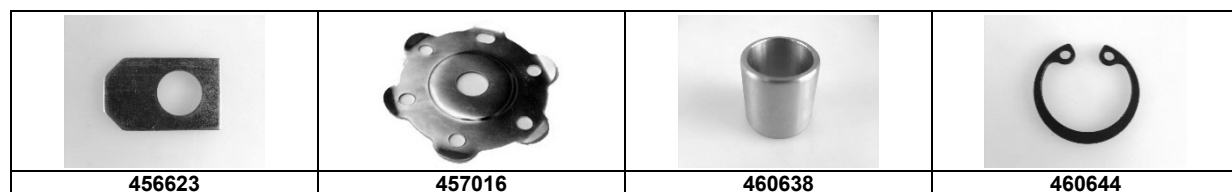
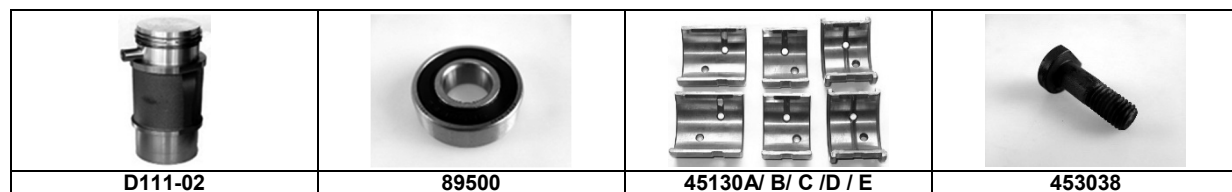

## VILEBREQUIN PISTONS

No d'article	article		Prix CHF
D121-010	BIELLE (A COUSSINET )	190x33mm	99.90
D121-2C	BAGUE DE PIED DE BIELLE	20x21,5mm	16.70
D121-91	PLAQUE ARRET VOLANT MOTEUR	5mm	36.40
D121-92	VIS VOLANT	M9x18	7.40
DM121-9	COUSSINET DE BIELLE JEU STD	4x2 48,00mm	59.90
DM121-9A	COUSSINET DE BIELLE JEU 0.25	4x2 47,75mm	59.90
DM121-9B	COUSSINET DE BIELLE JEU 0.50	4x2 47,50mm	59.90
DM121-9C	COUSSINET DE BIELLE JEU 0.75	4x2 47,25mm	59.90
DM121-9D	COUSSINET DE BIELLE JEU 1.00	4x2 47,00mm	59.90
DM121-9E	COUSSINET DE BIELLE JEU 1.25	4x2 46,75mm	66.20
DS121-13	VIS TETE DE BIELLE	M9x29	10.40
451378	GOUJON CHAPEAUX PALIERS	12x77mm	3.10
461178	PIGNON VILEBREQUIN 19 DENTS		50.00
D11111B	SEGMENT DE PISTON RACLEUR 5MM		18.90

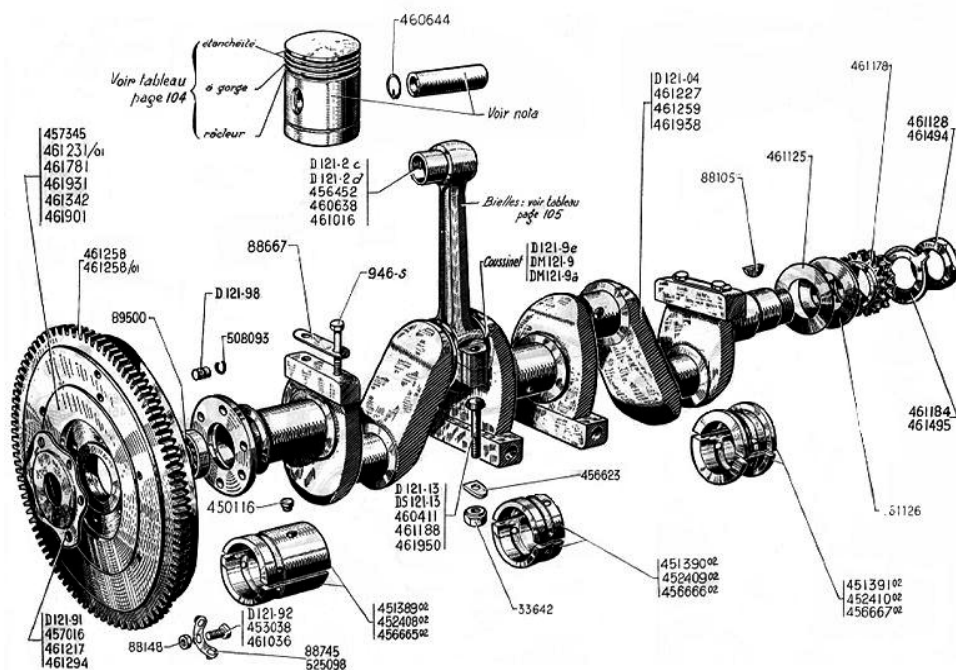
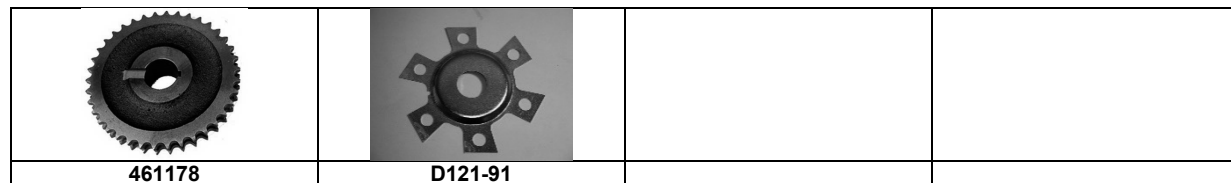
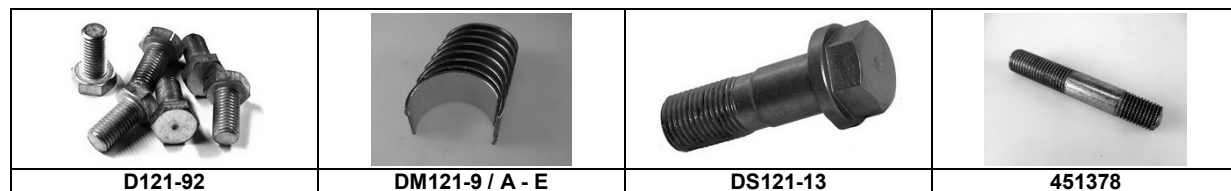
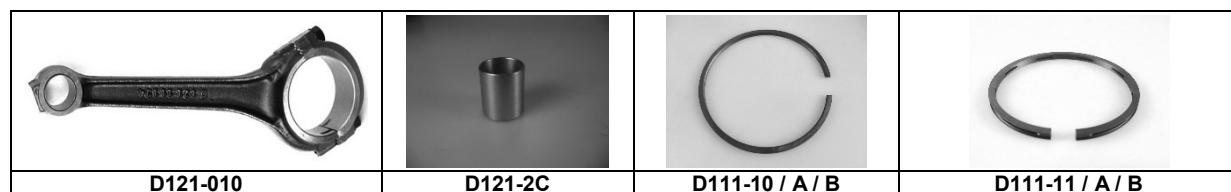

## ARBRE A CAMES ET SES COMMANDES

No d'article	article		Prix CHF
451513	POUSSOIR DE TIGE DE CULBUTEUR	Ø26x50x9mm	23.00
451718	RONDELLE POULIE COMMANDE	M9	0.40
451721	POULIE DE COMMANDE POMPE A EAU	Ø178x41,5mm	149.80
452427	ARBRE DE COMMANDE	-	112.10
457149	JOINT A CIER ENTR. ARBRE COMM	Ø25x21,7mm	42.60
461143	BRIDE DE BUTEE ARBRE A CAMES	80x57x3mm	12.00
461256	CHAINE DE DISTRIBUTION 66ANN.	66x3/8x7/32	62.40
461256S	TENSIONEUR CHAINE DISTRIBUTION	114x29mm	36.30
461492	ARRETOIR ECROU ARBRE A CAMES	24,5mm	6.30
461493	ECROU ARBRE A CAMES	M24x150	15.40
461849	TIGE DE COMMANDE CULBUTEUR	240mm	17.40
6.9906	VIS M7X15	M7x15	0.50
538-S	VIS POULIE DE COMMANDE	M9x25	15.90
88169	ECROU BLOCAJE POULIE DE COMM	M14x150	4.00
88795	ARRETOIR ARBRE A CAMES	8,5mm	4.20
89475	ROULEMENT AV ARBRE DE COMMANDE	20x47x14	29.70
89482	ROULEMENT AR ARBRE DE COMMANDE	20x42x10	20.20
A344-99D	RONDELLE REGL JEU ARBRE COMM	20x32x1mm	3.10
A344-99E	RONDELLE REGL JEU ARBRE COMM	20x32x0,1mm	1.80
D124-5	TIGE COMMANDE CULBUTEUR	245,8mm	24.90
D231-91	RONDELLE POULIE DE COMM	M9x28x4	1.60

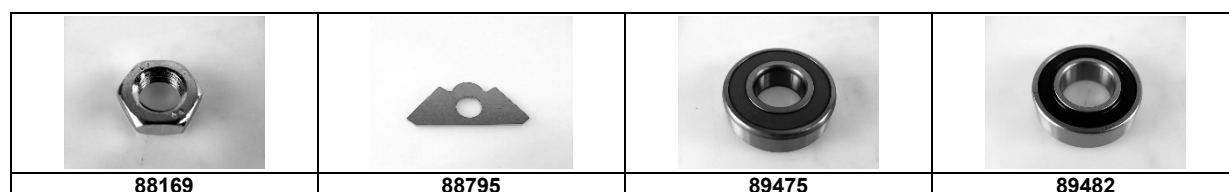
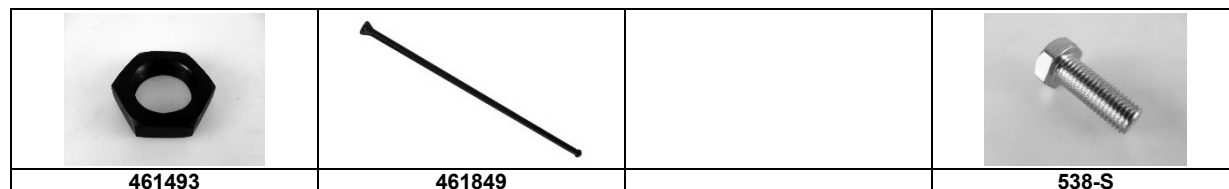
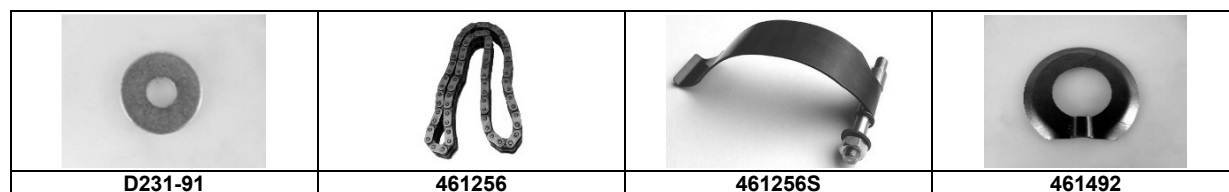
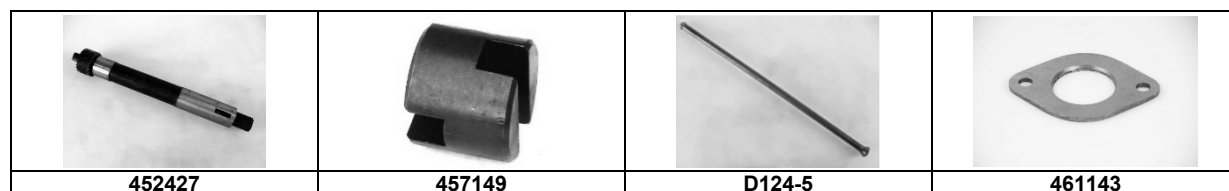

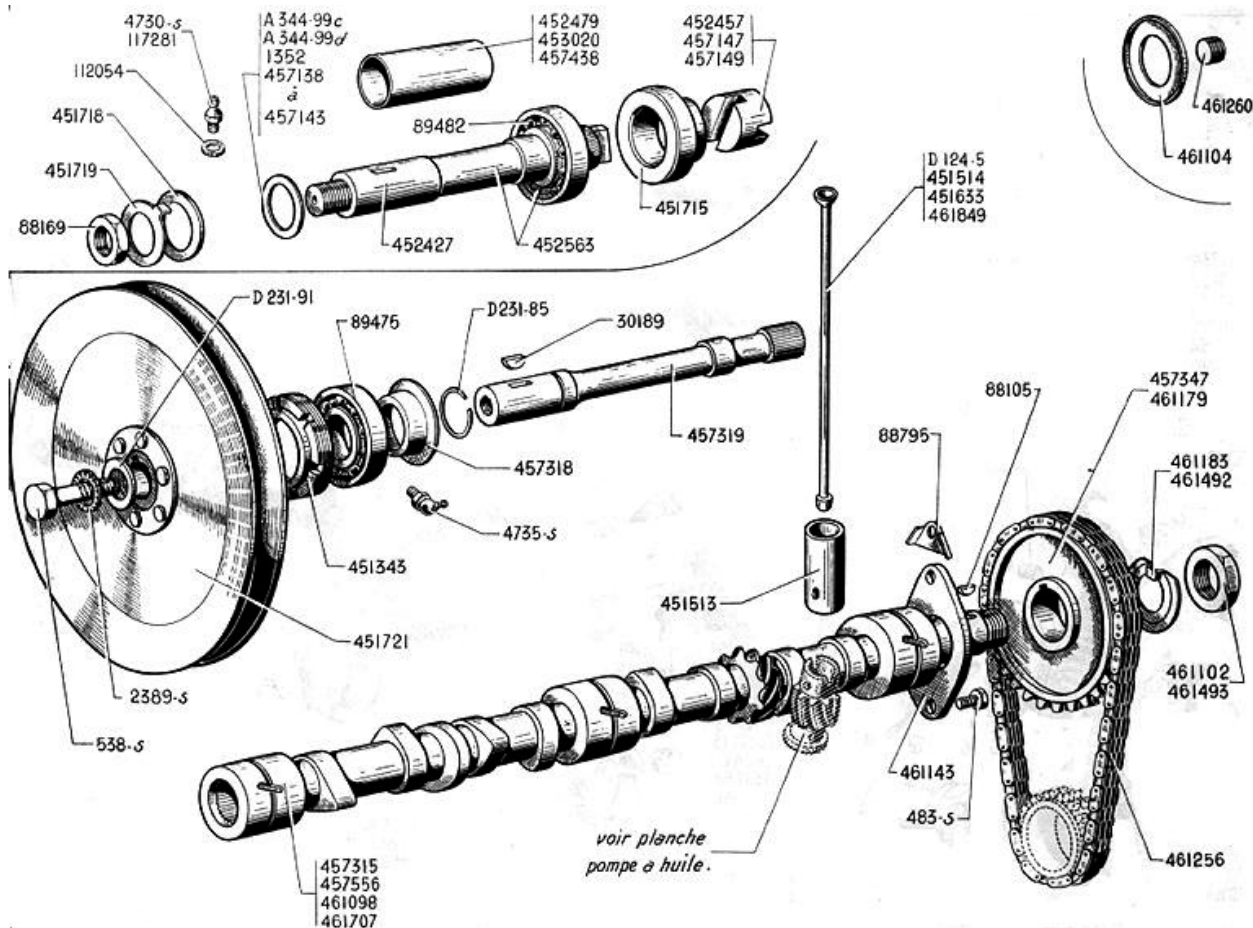

### CULASSE TUBULURES CULBUTEURS

No d'article	article		Prix CHF
1000-S	GOJONS TUBE AV COLLECTEUR	3xM10x40mm	1.80
1014-S	GOJON CULASSE	10x115mm	7.30
2372-S	ECROU FILTRE 17X6MM	M9x1,25	5.40
6.99010	ECROU COUVRE-CULASSE	M7x100	0.20
321261	JEU GOJON CULASSE/TUB. D ADM	7 stk/pc	9.60
33531	ECROU H (BORGNE) CULASSE	M10x150	3.50
451321	TUBE D EAU DE CULASSE	422x20mm	18.60
451323	JOINT DE COUVRE-CASSE LIEGE	44,5x15cm	9.00



## CULASSE TUBULURES CULBUTEURS

No d'article	article		Prix CHF
451323R	JOINT COUVRE-CULASSE CAOUTCH.	44,5x15cm	9.50
451331	ETRIER TUB ADM/ECHAPPEMENT	28x12mm	10.20
451397	SEGMENT ARRET CUVETTE SOUPAPE	H=8mm	13.90
451504	BOUCHON DESSABL. CULASSE 30MM	30mm	5.30
451505	BOUCHON DESSABL. CULASSE 25MM	25mm	4.70
451812	JOINT DE CULASSE NOUV. MOD	Ø72mm	89.00
452342	ERGOT CENTR TUBULURE ADMISSION	6x10mm	1.70
452565	ECROU TUBULURES/CUL M8 LAITON	M8x125	2.50
452762	BOUCHON REMPLISSAGE D HUILE	Ø110mm	55.10
452908	ETRIER CENTR TUBULURE ECH. 42	42mm	18.30
452914	RESSORTS EXT. DE SOUPAPES	Ø30x46,5mm	6.60
452996	JOINT TUBULURES ET CULASSE	186mm	17.60
453095	JOINT TUBULURES ADM/ECH	58 & 74mm	8.00
453105	JOINT DE CULASSE	Ø78 168x454mm	97.20
453112	TUBE ECOULEMENT ESSENCE	21cm	31.30
456174	TUBULURE ECHAPPEMENT	395mm 5j gar.	411.80
456998	JEU JOINTS SOUPAPES	7x11x2,5mm	5.90
457183	CUVETTE RESSORTS SOUPAPE ECH	H=9,5mm	2.30
457358	GUIDE DE SOUPAPE STD 11CV	13x53,5x9mm	14.50
457469	JOINT PLAQUE FERM. AR CULASSE	80x71mm	3.90
461107	SOUPAPE ECHAPPEMENT	Ø30,5x9x113,5mm	35.60
461113	ROTULE DE CULBUTEUR	M7x32mm	8.40

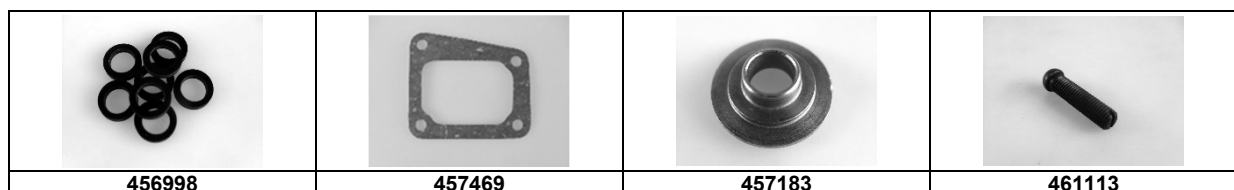
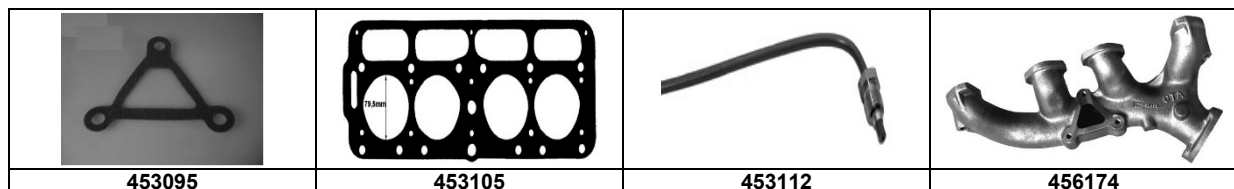
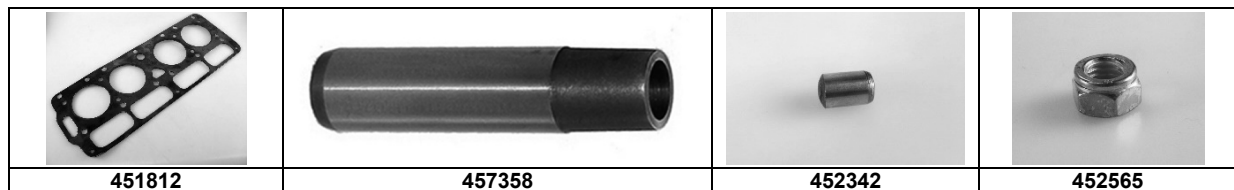
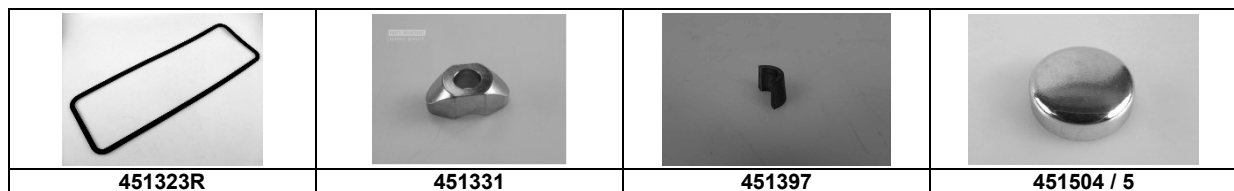



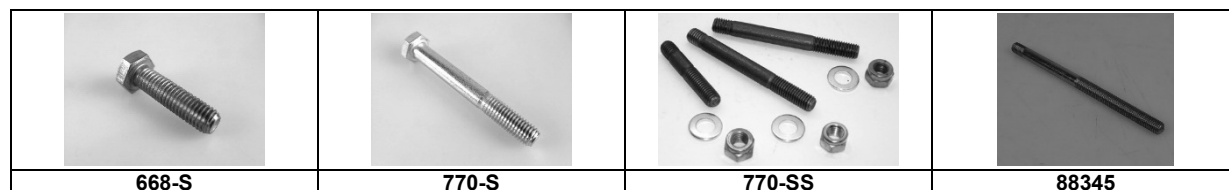
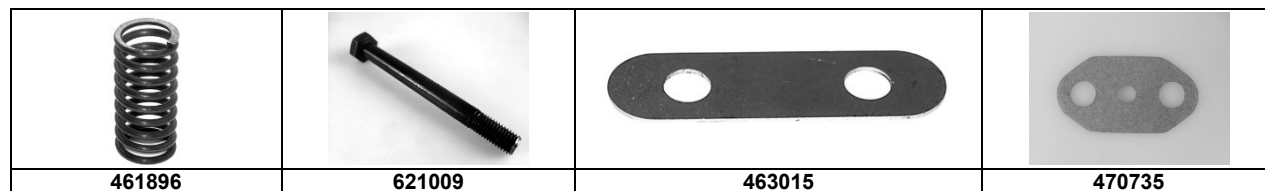
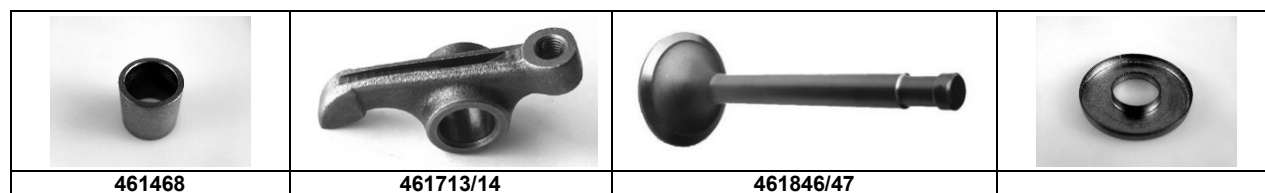
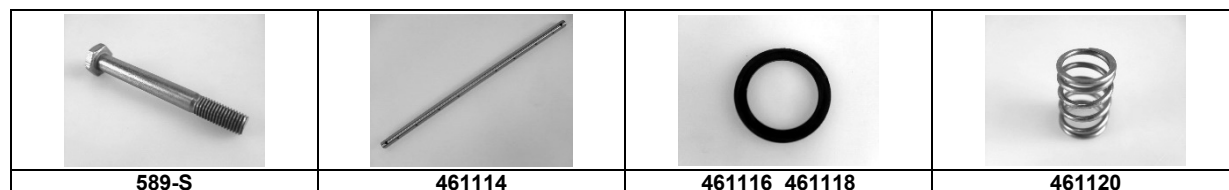
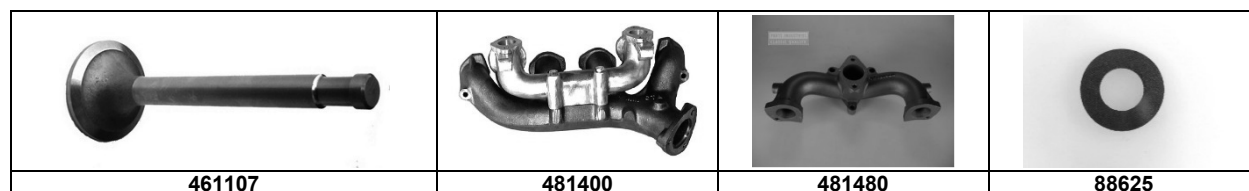

## CULASSE TUBULURES CULBUTEURS





No d'article	article		Prix CHF
461114	AXE DES CULBUTEURS	Ø14x417mm	55.40
461116	RONDELLE DES CULBUTEURS	14,5x20x1mm	2.40
461118	RONDELLE DES CULBUTEURS	14,5x3,5mm	2.40
461120	RESSORT ENTRE CULBUTEURS	14,5x27mm	1.40
461468	ENTRETOISE DES CULBUTEURS	18,5mm	2.20
461713	CULBUTEUR DROIT	Ø14x65mm	19.70
461714	CULBUTEUR GAUCHE	Ø14x65mm	20.10
461846	SOUPAPE ADMISSION	Ø37x9x101,5mm	19.10
461847	SOUPAPE ECHAPPEMENT	Ø33,8x9x103mm	18.80
461896	RESSORTS INT DE SOUPAPES PAR	Ø20x43mm	4.50
463015	ARRET DBLE SUPP AXE CULBUTEURS	27x52x15mm	3.60
470735	JOINT SUPPORT AXE CULBUTEURS	22x42x26mm	1.10
481400	TUBULURE ADMISSION DOUBLE	32mm	385.90
481480	TUBULURE ADMISSION	32mm	195.00
589-S	VIS SUPPORT AXE CULBUTEURS	M7x60mm	3.60
621009	VIS CULASSE	10x102mm	12.70
668-S	VIS M8X27.5	M8x27,5	0.50
770-S	VIS M8X65	M8x65	1.50
770-SS	JEU GOUJONS TUBULURES	3 stk/pc	12.20
88345	GOUJON SUPPORT AXE CULBUTEURS	M7x112mm	5.10
88625	RONDELLE COUVRE CULBUTEURS	7,5x20x1,5mm	2.40



### CULASSE TUBULURES CULBUTEURS

No d'article	article		Prix CHF
D112-01B	BAGUE ORIFICE DE BOUGIE	34x45mm	13.10
D112-4	VIS CULASSE	10x102x25mm	10.70
D124-2	CULBUTEUR GAUCHE	16mm	31.90
D124-2A	CULBUTEUR DROIT	16mm	31.90
D124-6	AXE CULBUTEURS	Ø16x417mm	50.30
D124-7	SOUPAPE ADMISSION	Ø37x9x108,5mm	25.20
D124-8	SOUPAPE ECHAPPEMENT	Ø33,8x9x110,6mm	29.10
D124-85	RONDELLE DES CULBUTEURS	16,5x20x0,9mm	1.30
D124-88	GOUJON COUVRE-CULASSE M9	9x128,5mm	10.10
D132-72	BAGUE ETANCH COUVRE-CULASSE	9x15x21x5mm	14.80
457287	BOUCHON REMPLISSAGE HUILE	Ø69mm	54.10
6.16016	GOUJON M7	M7 x 38	2.60
321261S	JEU GOIJON CULASSE/TUB. D ADM		12.20

			
<b>321261S</b>	<b>89860</b>	<b>D112-01B</b>	<b>D112-4</b>

			
<b>D124-2 2A</b>	<b>D124-6</b>	<b>D124-7 D124-8</b>	<b>D124-85</b>

			
<b>D124-88</b>	<b>D132-72</b>	<b>457287</b>	



## BOITE DE VITESSES CARTER

No d'article	article		Prix CHF
2474-S	JOINT BOUCHON VIDANGE BOITE	24x32x2mm	2.40
2666-S	ARRETOIR SIMPLE CHAPEAU PALIER	12,5mm	3.70
2950	BOUCHON VIDANGE HUILE BOITE	M24x2x26	5.10
2950-M	BOUCHON VIDANGE BOITE MAGN	M24x200	24.70
450014	JOINT CARTER VOLANT/EMBRYAGE	-	1.90
451429	VIS DE FIXAT ALTERNATEUR	10x135mm	4.60
452472	PLAQUE FERMETURE CARTER VOLANT	-	21.60
457316	BAGUE RET HUILE CARTER VOLANT	16,4x42x12mm	14.90
486-S	VIS DE FIXAT. DU CARTER VOLANT	M7x25,5	8.80
493108	VIS DU CARTER VOLANT MOTEUR	7x38,5mm	8.30
493126	PLAQUE FERMETURE CARTER VOLANT	-	20.90
493127	VIS CARTER VOLANT-MOTEUR	7x46mm	10.60
495-S30	VIS M7X45		1.70
500539A	BOUCHON AV ARBRE PRIM CHROME	Ø54,4x50	31.10
500835	POCHETTE BOITE DE VITESSE	5 stk/pc	11.10
500963	GOIJON CENTR COUVERCLE BOITE	M8x40, 10&18mm	1.10
508513	ARRETOIR DOUBLE CHAPEAU PALIER	104mm	4.10
601027	VIS CARTER VOLANT-MOTEUR	M10x38mm	10.60
501049	POCHETTE BOITE DE VITESSE 7 PIECE		19.50

			
<b>508513</b>	<b>2474-S</b>	<b>2666-S</b>	<b>2950</b>
			
<b>2950-M</b>	<b>450014</b>	<b>451429</b>	<b>452472</b>
			
<b>457316</b>	<b>486-S</b>	<b>493108</b>	<b>493126</b>
			
<b>493127</b>	<b>495-S30</b>	<b>500539A</b>	<b>500835</b>
			
<b>601027</b>			

Voir Tableau page 163

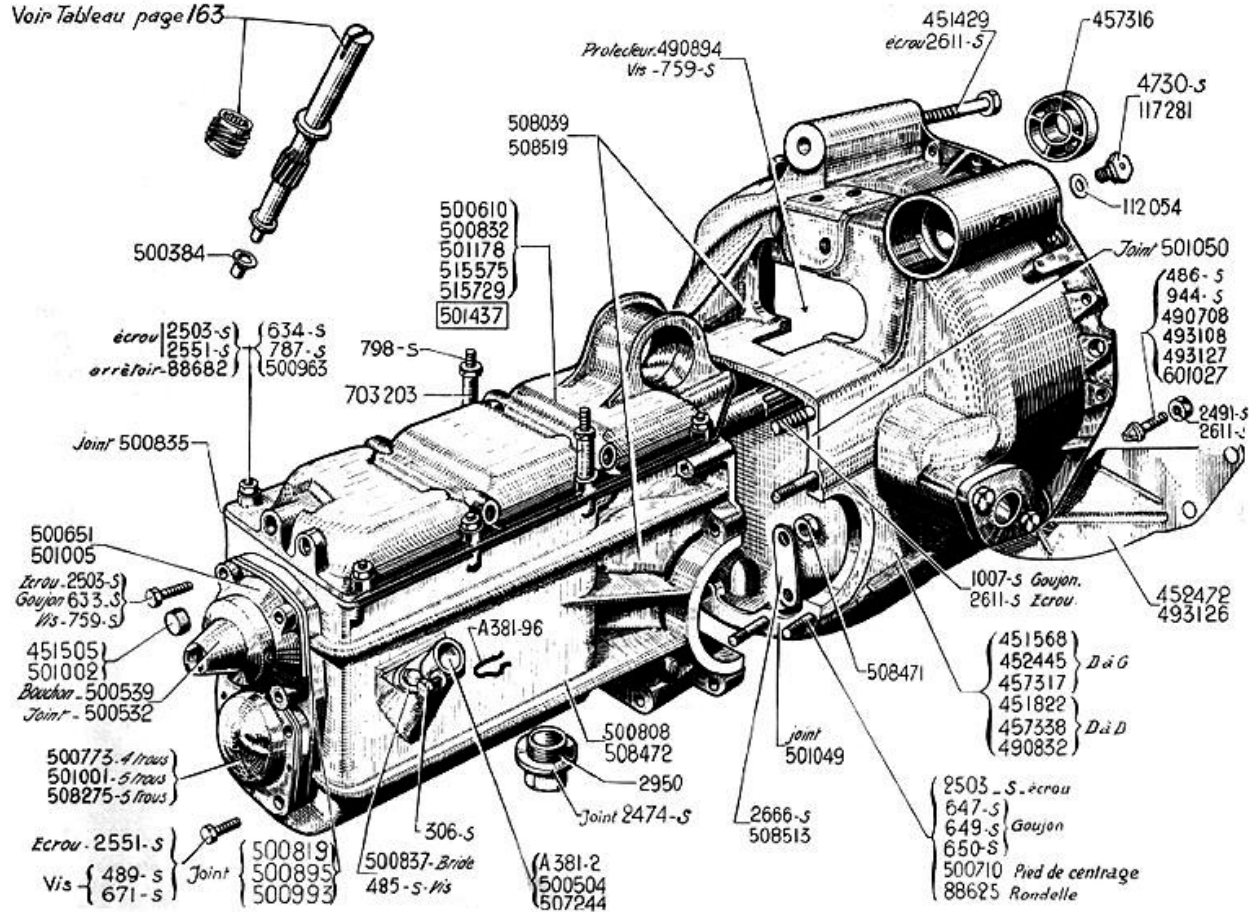

### PIGNONS ARBR

No d'article	article		Prix CHF
2713-S	BILLE PIGNON INTERM. AR	6,35mm	0.40
2714-S	BILLE DU CLAPET DE DECHARGE	9,52mm	1.70
461681	RONDELLE REGLAGE COURSE 3IEME	14x20x0,3	2.70
461681A	RONDELLE REGLAGE COURSE 3E	14x20x0,5	1.30
461681B	RONDELLE REGLAGE COURSE 3E	14x20x1	1.30
500367	ROULEMENT AR ARBRE SECONDAIRE	72x30x19mm	68.70
500374	ARRET ECRU BLOC ROUL AV SEC	26,5mm	6.60
500521	BA GUE 3IEME PIGNON	30x34x33,5mm	15.80
500523	JEU BA GUE 2E PIGNON	30x34x23	35.60
500525	RONDELLE CELORON 30X50X2.8	30x50x2,8mm	10.20
500525A	RONDELLE CELORON 30X50X2.9	30x50x2,9mm	10.20



## PIGNONS ARBR













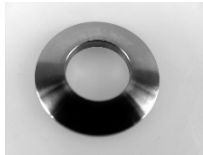

No d'article	article		Prix CHF
500527	RONDELLE SECURITE DES CRABOTS	30.2x44.7x3.75mm	20.70
500528	CLAVETTE PLATE DU PIGNON	55,5x5x3,3mm	18.10
500533	DEMI-ROND. ARRET PIGNON 1E/AR	40x5mm	7.10
500537	FOURCHETTE COMM 1E/AR	37mm	74.30
500538	FOURCHETTE COMMANDE 2E ET 3E	92,5x6,7mm	99.00
500756	PIGNON BALADEUR 1E/AR	Ø56x23,5 20td	42.30
500761	PIGNON DE PRISE DIRECTE BAGUE	22 td	522.00
500763	PIGNON FOU BAGUE 2E/ARBRE PRIM	16/24 td	695.00
500775	RONDELLE CELORON 30X50X2.5	30x50x2,5mm	10.20
500840	GOUPILLE DE MISE EN MARCHE	7x23mm	3.00
501026	RONDELLE CELORON 30X50X3	30x50x3mm	10.20
501026A	RONDELLE CELORON 30X50X3.1	30x50x3,1mm	10.20
501026B	RONDELLE CELORON 30X50X3.2	30x50x3,2mm	10.20
506294	RESSORT DU SYNCHRONISEUR	6x12mm	2.40
506979	SEGMENT ARRET EXT. ROULEM. AR	36x27x1mm	0.80
507206	PIGNON RENVOI 2E/ARBRE SEC.	34td	52.10
507270	PIGNON 1E/AR ARBRE SEC.	26/39td.	313.00
507271	BAGUE PIGNON FIXE 1E ET AR.	30x34,38	27.40
507272	RONDELLE SECURITE DES CRABOTS	30.2x44.7x3.80mm	20.70
508006	VIS AV ARBRE PRIMAIRE	24x150	31.00
508068	BAGUE EPAULEE PIGNON INTERM AR	18x23x36mm	17.80
508069	PIGNON FOU INTERM. AR	16x32	175.40
611007	ARR TALONS ECROU AV ARBRE PRIM	25,5mm	6.10

			
<b>500527</b>	<b>500528</b>	<b>500533</b>	<b>500537</b>
			
<b>500538</b>	<b>500756</b>	<b>500761</b>	<b>500763</b>
			
<b>500775</b>	<b>5007271</b>	<b>500840</b>	<b>501026 / A / B</b>
			
<b>508069</b>	<b>506294</b>	<b>506979</b>	<b>507206</b>
			
<b>507270</b>	<b>507272</b>	<b>508006</b>	<b>508068</b>



## DIFFERENTIEL

No d'article	article		Prix CHF
408281	AXE DE SATELLITES	14x109mm	37.20
408293	VIS COURONNE SUR BOITIER	M10x26	10.60
408304	RONDELLE APPUI DES SATELLITES	2,95mm	8.90
408305	RONDELLE APPUI DES SATELLITES	3 mm	8.90
408306	RONDELLE APPUI DES SATELLITES	3,05mm	8.90
408307	RONDELLE APPUI DES SATELLITES	3,10 mm	8.90
408308	RONDELLE APPUI DES SATELLITES	3,15mm	8.90
408308B	RONDELLE APPUI DES SATELLITES	3,5mm	8.90
408308C	RONDELLE APPUI DES SATELLITES	3,6mm	8.90
408308D	RONDELLE APPUI DES SATELLITES	3,2mm	8.90
408308E	RONDELLE APPUI DES SATELLITES	3,25mm	8.90
408308F	RONDELLE APPUI DES SATELLITES	3,3mm	8.90
408308G	RONDELLE APPUI DES SATELLITES	2,9mm	8.90
408308H	RONDELLE APPUI DES SATELLITES	2,85mm	8.90
408315	RONDELLE PLA TEAU ENTR TRANSM.	14,5x32x3mm	2.30
408319	CLAVETTE ARRET AXE SATELLITES	Ø7x36,5mm	3.10
408355	PIGNON SATELLITES 8 DENTS	8 td 10/34>	122.40
408442	BAGUE DE DIFFERENTIEL	27x31x43mm	21.80
408451	ROULEMENT BOITIER DIFFERENTIEL	40x80x19,5mm	39.80
408453	JOINT SPI ETANCH DIFFERENTIEL	36x83x12mm	10.30
508354	PLA TEAU ENTR. TRANSMISSION M10	79x70x39mm	203.90
508425	AXE SATELLITES ARRET PAR VIS	14x109	37.20
508460	COUPLE CONIQUE 9 X 31	9x31 Ø40mm	1692.00
508512	VIS TR ACCOUPLEMENT CARDAN M10	10x31mm	6.20
611008	ARRETOIR DOUBLE VIS COURONNE	105x365	4.10
99146	SP-SLEEVE PLA TEAU ENTR TRANSM	36mm	62.90

			
<b>408281</b>	<b>408293</b>	<b>408453</b>	<b>408304 – 408308 H</b>
			
<b>408315</b>	<b>508354</b>	<b>408319</b>	<b>508425</b>
			
<b>408355</b>	<b>408442</b>	<b>408451</b>	<b>508460</b>
			
<b>508512</b>	<b>611008</b>	<b>99146</b>	

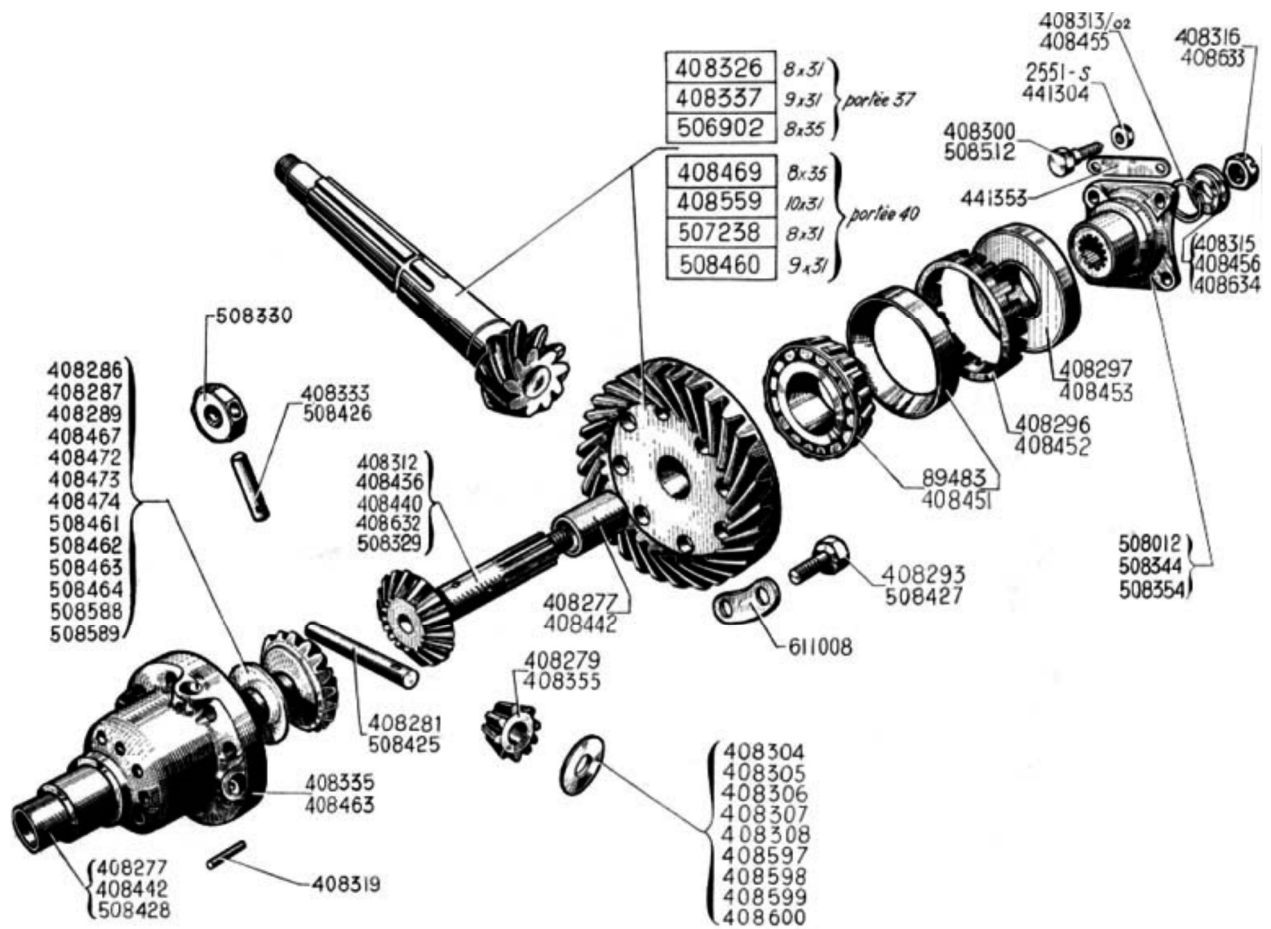

### COMMANDE DES VITESSES

No d'article	article		Prix CHF
118300	AXE CHAPE DE CABLE DE TIRETTE		3.80
23-S	VIS DE LA PLAQUE RECTANG IND	3x10mm	0.50
3288-S	JEU DE REPARATION LEVIER/SEL	12x15x12	19.60
515492	AXE LEVIERS COMMANDE DANS SUPP	12x63mm	18.20
515508	ROTULE ARBRE COMM VITESSE ROND	16,6mm	9.90
515511	CLAVETTE LEVIER SUP. 1IERE/AR	4x15,5x4,7mm	5.50
515522H	GRILLE DE GUIDAGE DU SELECTEUR	90x50x4mm	26.20
515582	BOULE LEVIER VITESSES	-	26.80
515592	GARNITURE CAOUTCH RECT. TIGES	54x95mm	5.70
515593	PLAQUETTE GARNITURE 515592	54x95mm	7.00
515792	RONDELLE EPAULEE RESS ROTULES	8x14x2	0.60
515793	RESSORT DE ROTULE	Ø12x10,5mm	7.00
515891	RESSORT DE SELECTEUR + RIVET	69x16x0,6mm	14.40
516038	ROTULE ARBRE COMM VITESSES	15mm	9.90
88103	CLAVETTE LEVIER SUP. 2IEME/PD	2,5x12,5x5,15mm	5.30

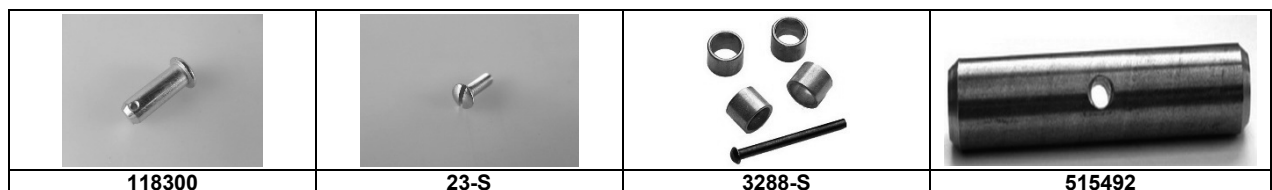

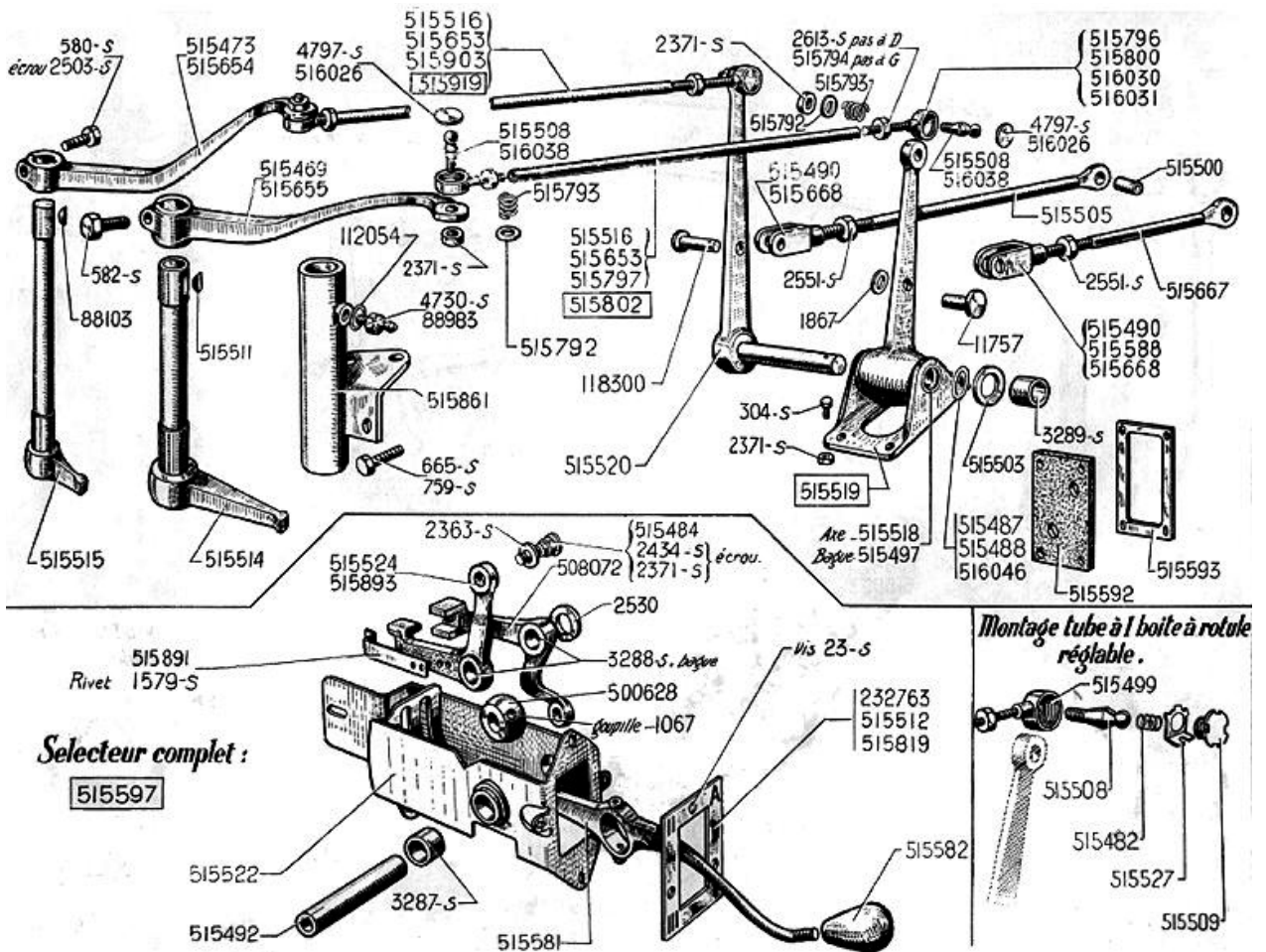
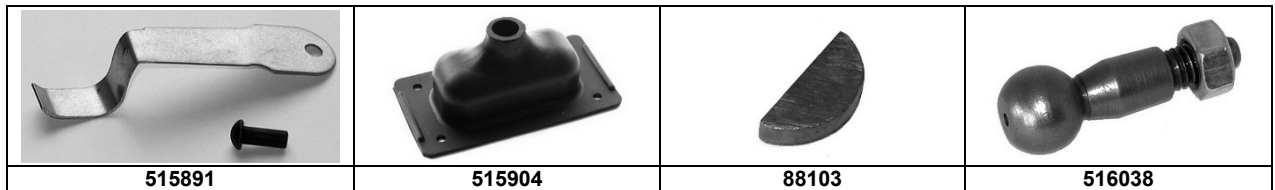
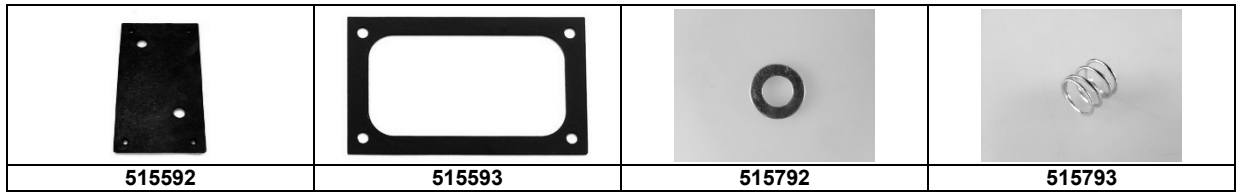

## POMPE A HUILE

No d'article	article		Prix CHF
10378	CLAVETTE WOODRUFF PIGNON FIXE		10.50
1099	JOINT FIBRE TUYAU GRAISSAGE		0.40
2714-S	BILLE DU CLAPET DE DECHARGE		1.70
451354	RESSORT CLAPET DECHARGE	9,5x40mm	11.60
451366	JOINT TOLE CARTER DE POMPE	0,2a0,3	2.30
451899/900	JEU DE PIGNON POMPE A HUILE	24,9x30mm	63.80
452686	TAMIS FILTRE A HUILE SUP	Ø30x150	18.70
452719	TAMIS FILTRE A HUILE INF	Ø11x150	20.60
453117	JOINT FOND POMPE TOLE SUP.	Ø42x29mm	2.00
453130VT	VENTIL POMPE A HUILE +BOUCHON		177.80
453195	JOINT FOND DE POMPE ET TOLE	perfo	2.10
457220	JOINT ENTRE TOLE/CARTER POMPE	0,05mm	2.60
457371	ARBRE DE COMMANDE DU PIGNON	12,5x288mm	44.60
457372/02	SEGMENT ARRET DE PIGNON FIXE	7mm	5.90
457373/4	JEU DE PIGNON POMPE A HUILE	24,9x30mm	69.00
470376	JOINT TUY. GRAISS. CULBUTEURS	15x42mm	1.20
470481	TUYA UTERIE GRAISS. CULBUTEURS	225mm	66.70
6.9902	VIS M7X15	M7x16	0.90
88540	GOUPILLE DU PIGNON	3,5x20mm	2.30
D224-1	TUYA UTERIE GRAISS CULBUTEURS	208mm	58.10
DS222-5	RESSORT DE CLAPET DE DECHARGE	8,6x70mm	9.40
451354S	KIT RESSORT BILLE ARRETOIR		14.20

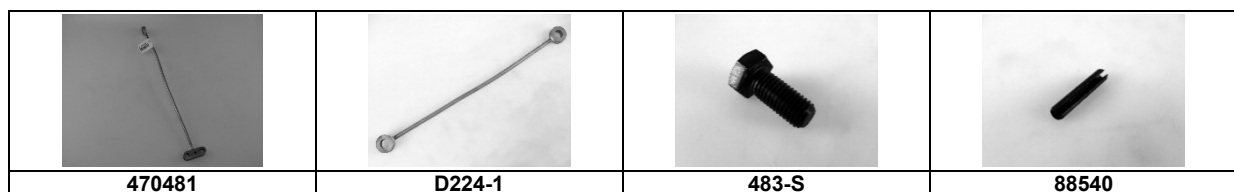
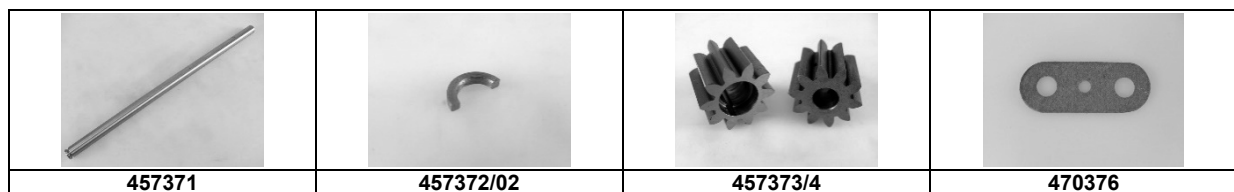
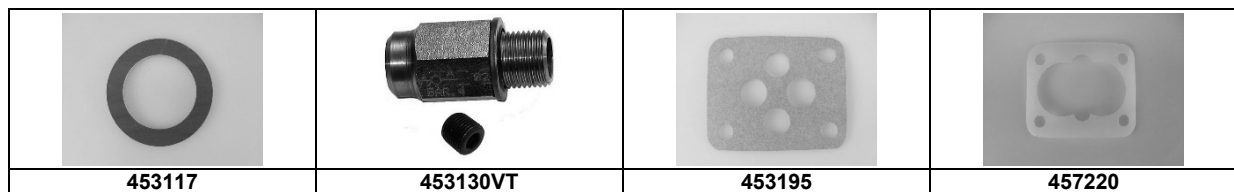
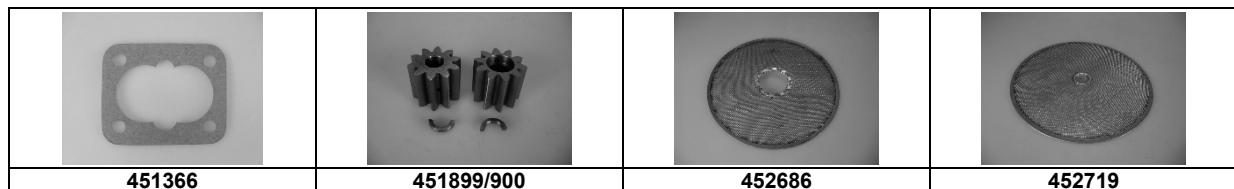

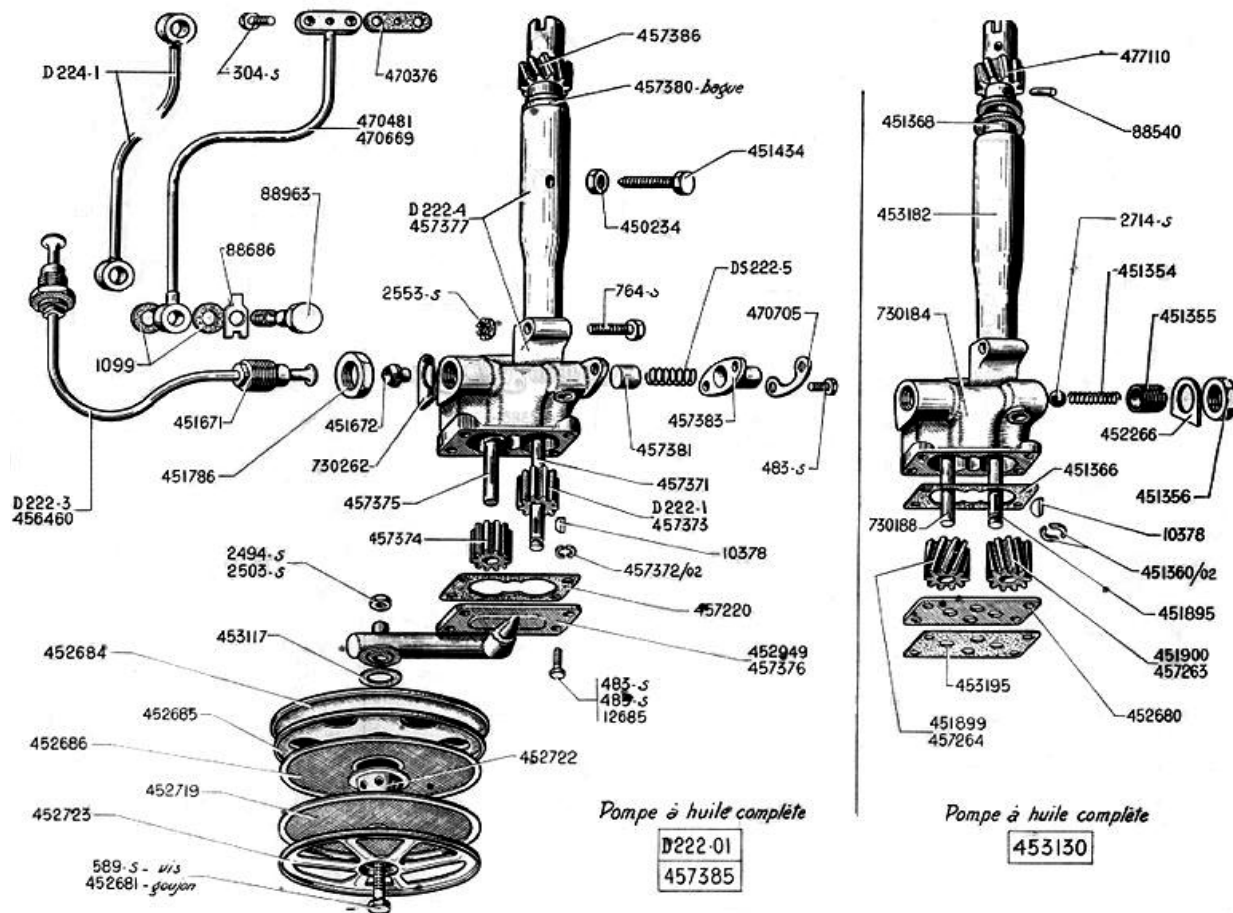

### RADIATEUR

No d'article	article		Prix CHF
190000K	CLIPS HOUSSE EVERWARM		1.90
2321-S	ECROU ENJOLIVEUR CAPOT/GRILL	20x15mm	2.90
2611-A	VIS SPECIAL RADIA TEUR DESSOUS		12.90
2611-S	ECROU DE FIXAT RADIA TEUR M10	10x150	0.90
302771A	BRIDE DE TUYAU	Ø50mm	3.90
302900I	RADIA TEUR BLOC CUIV RE	40cm B	502.70
302901I	RADIA TEUR BLOC CUIV RE	46cm B	535.00
32301215S	CLIP TUYAU CHAUFFAGE 15MM	Ø23mm	2.30



## RADIATEUR

No d'article	article		Prix CHF
329525	MOTIF SUR HAUT CALANDRE	97x30mm	43.80
329600	RONDELLE CAOUTCHU RADIA TEUR	Ø29x12mm	2.00
329607	PATTE LIAISON FAISC/CALANDRE	110x25mm	18.80
329608	PATTE LIAISON FAISC/CALANDRE	125x25mm	17.60
329621	MOTIF SUR HAUT CALANDRE	124x31mm	40.80
329627	BOUCHON RADIA TEUR	60x200	39.90
329628	JOINT DU BOUCHON DE RADIA TEUR	44x59x3	2.50
329642	DURITE INF RADIA TEUR	50x430mm	24.20
329739/40	JONC DE CALANDRE D+G BL	2 stk/pc	107.70
330118	JEU DE A GRAVE JONC DE CALANDRE	4mm	8.70
330577	DURITE SUPERIEURE DE RADIA TEUR	50x360mm	20.90
331101	BOULON DE CALANDRE INOX	M8xØ20x25mm	12.00
331101F	JOINT FIBRE BOUL CALANDRE INOX	8x16mm	0.50
331109	CACHE ENTREE MANIVELLE OVALE	23x7,5cm	110.40
331137	CACHE ENTREE DE MANIVELLE	15x13,5cm	74.00
331137R	CACHE ENTREE MANIVELLE ETOILE	Ø90mm	79.00
331147	TUBE CAOUTCHOU DE TROP-PLEIN	485mm	5.90
331152	CHEVRON JEU DE BANDE	4 stk/pc	142.00
331156	JEU DE A GRAFE FIXAT CHEVRONS	4 stk/pc	1.80
451000	REGULATEUR THERMOSTATIQUE	Ø40mm 83°C	54.00
600303S	COLLIER SERRAGE ROBINET CHAUFF	Ø24,5mm	7.20
451004	TURBINE CENTRIFUGE ELEC. EXTRA 12 V		155.00
329600S	JEU RONDELLE CAOUTSCHUC ECROU		7.40

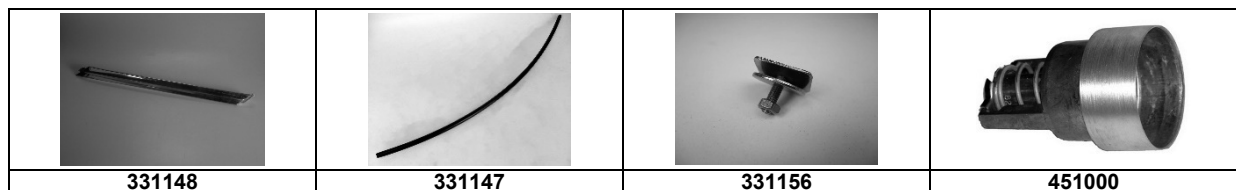
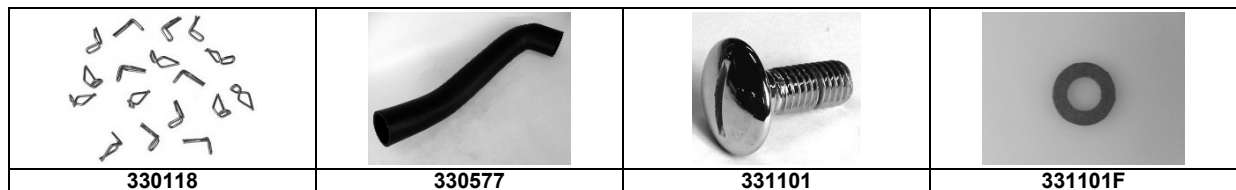
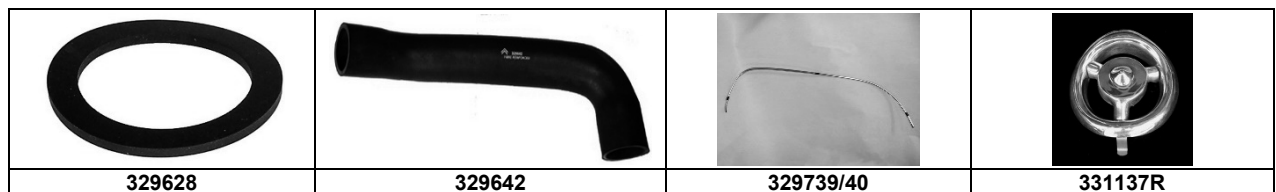
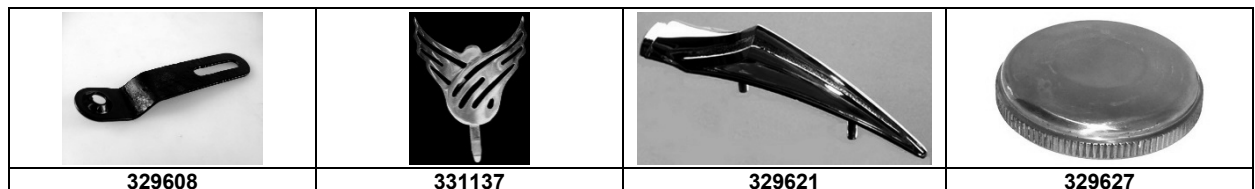

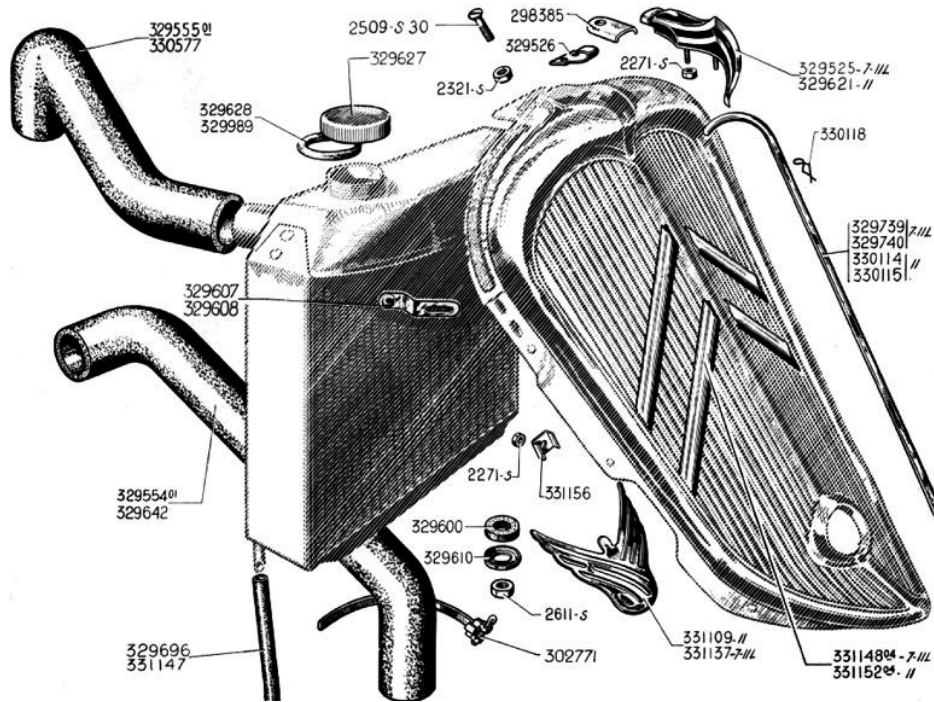



### POMPE A EAU VENTILATEUR





No d'article	article		Prix CHF
2614-S	ECROU H CRENELE BLOCA GE POULIE	M10x1.5	3.90
30189	CLAV POMPE EAU/ALT/ARBRE COMM.	4x15,5mm	1.50
3293-S	DOUILLE CORPS DE POMPE A EAU	Ø15x19x32mm	9.50
451405A	DOUILLE DE CORPS DE POMPE NM	28,2x31,5	17.40
451845	COURROIE CONIUE DUC P-RH	17x1000	33.10
451847	TENDEUR DE COURROIE	237,5x62,5mm	14.80
451972	JOINT ENTRE COUVERCLE DE POMPE	115x74mm	4.50
453217	VENTILA TEUR 6 PALES	330mm	62.10
453218	ENTRETOISE DU VENTILA TEUR	8,5x16x8mm	4.20
456399	BAGUE POMPE A EAU	15x35x12mm	14.40
456399SA	RONDELLE COMPENS BAGUE ETANCH	15x21x0.3mm	0.90
456904A	ARBRE DE POMPE A EAU	Ø15x205mm	34.80
456904	TURBINE DE POMPE A EAU	80mm	151.20



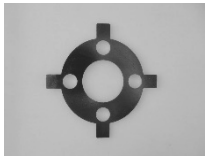



## POMPE A EAU VENTILATEUR

No d'article	article		Prix CHF
461835	VIS POU E VENTILATEUR/POULIE	M6x25	9.30
461837	ARRETOIR VIS VENTILATEUR	-	6.10
472394	SEGMENT ARRET ROULEMENT	H=9,4 mm	7.30
456909	JOINT POMPE/COUVERCLE GRAND		10.10
472395	TOLE RETENUE SEGM ARRET ROULEM	15,5x21x28mm	8.40
6.16016	GOUJON FIXAT COUVERCLE/TENDEUR	M7x38	2.60
700175	GRAISSEUR DOUILLE CORPS POMPE	-	12.20
700914	TENDEUR DE COURROIE	225x82,5mm	19.40
88982	GRAISSEUR DBLE CLAPET DOUILLE	M8x125	19.00
89951	ROULEMENT BILLES ARBRE POMPE	15x42x13mm	22.80
D231-88	JOINT POMPE A EAU PETIT	75x93mm.	3.60
456463	POMPE A EAU TURBINE 80 mm		349.00
451845D	COURROIE 1050 mm		35.10

			
<b>456904A</b>	<b>456909</b>	<b>461835</b>	<b>461837</b>

			
<b>472394</b>	<b>472395</b>	<b>6.16016</b>	<b>700175</b>

			
<b>700914</b>	<b>88982</b>	<b>89951</b>	<b>D231-88</b>

			
<b>456463</b>			

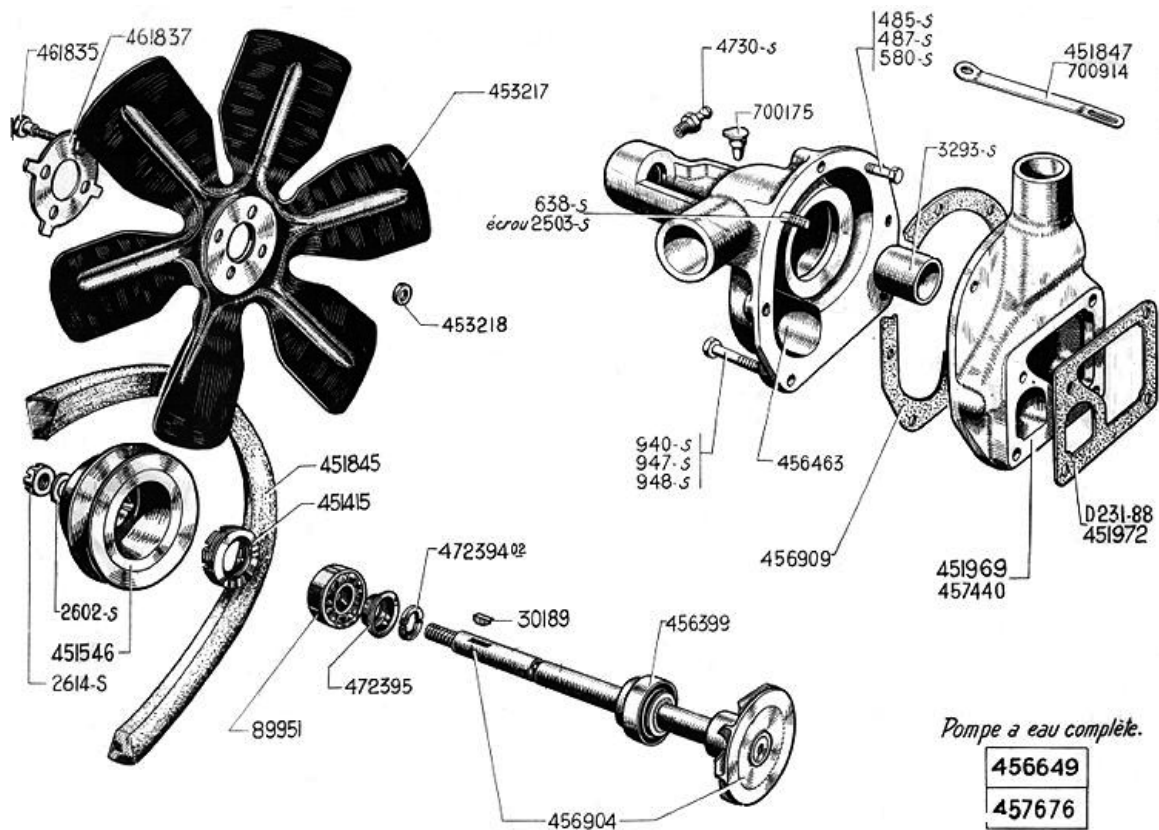

### EMBRAYAGE

No d'article	article		Prix CHF
18325	CHEVILLE D ARRET PAL. DE BUTEE	3x7mm	0.30
6.99010	ECROU M7X100	M7x100	0.20
451570	BA GUE DE FOURCHE DE DEBRAY AGE	20x23.17X18mm	14.80
452334	RESSORT RAPPEL SUPPORT BUTEE	10x31mm	4.30
452741	PIED CENTRAGE COURONNE-CARTER	8,5x12x9mm	4.50
490270	LINGUET DE DEBRAY AGE	80x48mm	25.50
490271	RESSORT DE RAPPEL DE LINGUET	Ø9,5x24mm	5.30
490272	RONDELLE ARTICULATION LINGUET	16x8,5x2,5mm	3.70
490371	RONDELLE EPAULE APPUI LINGUETS	31x57x8	29.90
490372	CUVETTE HUILE DE BUTEE BILLES	-	16.10
490662	VIS DU CARTER EMBRAY AGE	M8x20x13	2.40
490986	DISQUE EMBRAY AGE NEUF	Ø214x4x4mm	67.70



## EMBRAYAGE

No d'article	article		Prix CHF
491007	RIVET GARNITURE DISQUE EMBRAY.	4x6mm	0.20
493019	RESSORT EMBRAYAGE	19x26,5x47mm	6.10
493023A	MECANISME EMBRAYAGE DIAPHRAGME		324.00
493023AS	MECANISME EMBRAYAGE DIAPHRAGME		730.00
615002	ECROU DE BOULON DE DEBRAYAGE	M8x1	8.70
622751	VIS REGLAGE LINGUETS DEBRAYAGE	8x43x18mm	14.50
88989	GRAISSEUR HUILE BUTEE BILLES	M8x125	11.40
89971	SUPPORT DE BUTEE BILLES +BUTEE	31x72x19	119.50
601027	VIS CARTER VOLANT-MOTEUR		10.60
89971L	SUPPORT DE BUTEE BILLES +BUTEE DIAFRAG		35.00

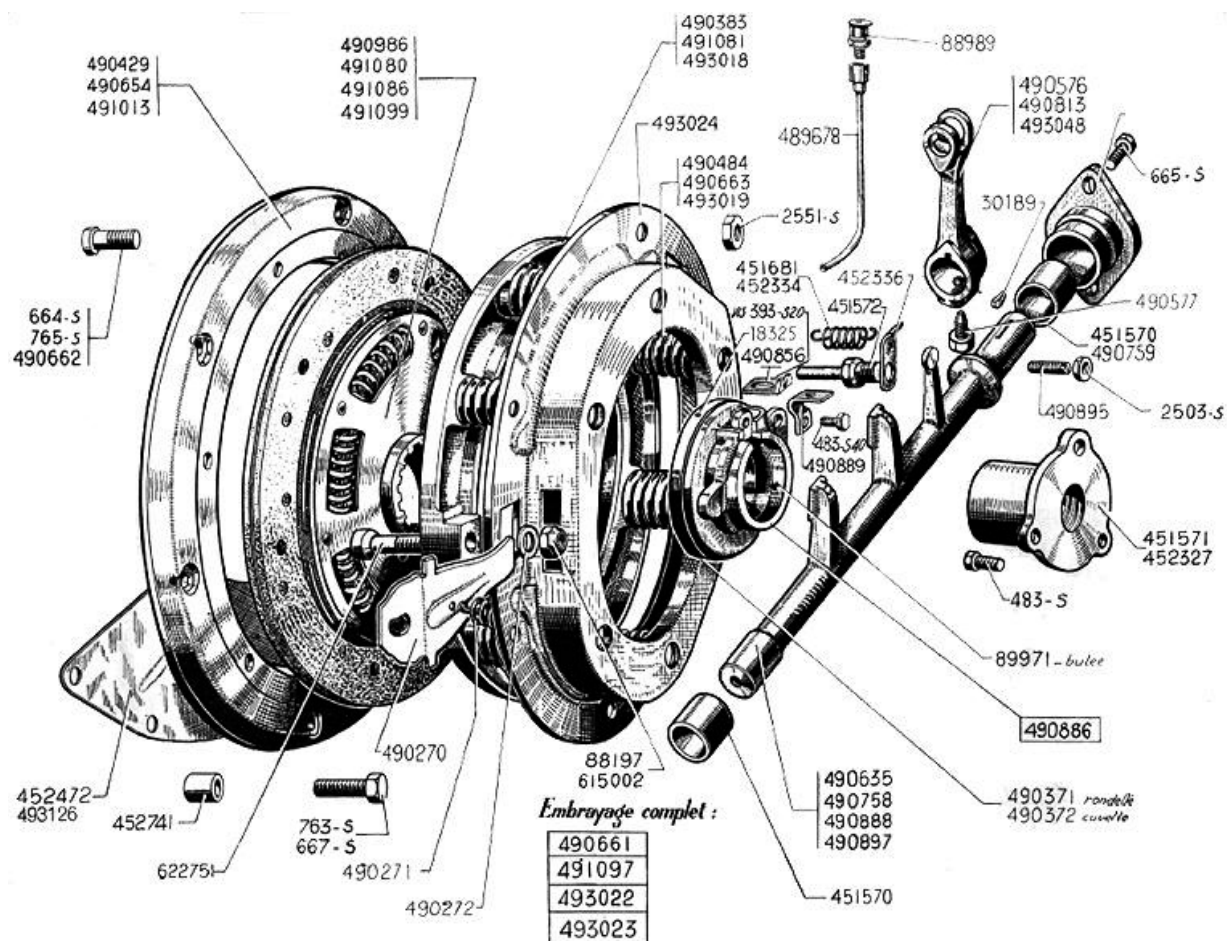
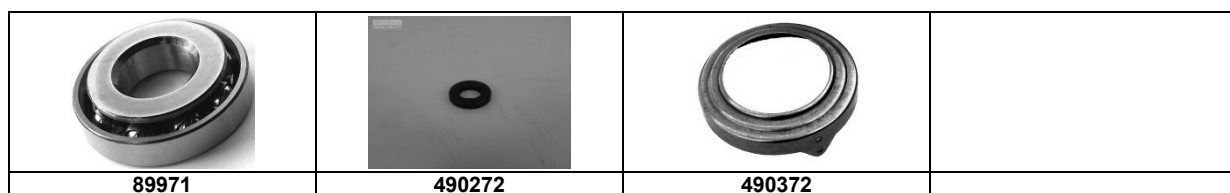
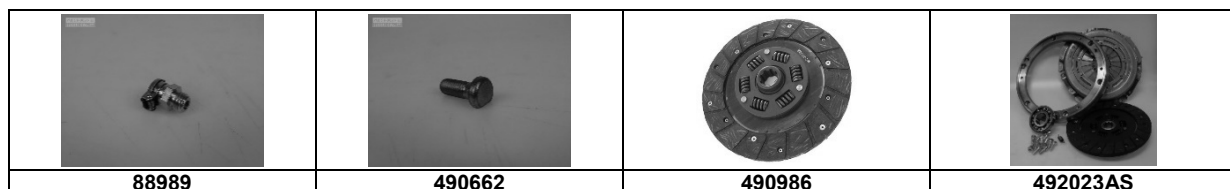

## CARBURATEUR FILTRE AIR

No d'article	article		Prix CHF
452795	JOINT DE CARBURATEUR ENTR AXES	hoh 65x0,7mm	5.90
480378	ECRAN DE PROTECTION CARB 35	27x12cm	51.30
480393A	JEU REP SOLEX 32/34 PBIC	set	35.80
480393B	POCHETTE JOINTS CARB 35 FPAI	set	33.60
480393Z	POCH JOINTS CARB ZENITH 32IN	set	43.50
481477	ECRAN DE PROTECTION CARB 32/34	27x12cm	47.50
6.16020	JOINT CARBURATEUR 5MM BAKELITE	Ø33x77x50x5mm	12.30
481489	RACC CAOUTCH COLL FILTRE A AIR	51x61x68x16mm	8.10
481717	JOINT CARB TROU CENTRAL 34MM	34x1mm	3.70
481-S	VIS FITRE A AIR TUBULURE ADM	M7x10	1.70
587414	ROTULE ARTICULATION TIGE COMM	M7x43mm	7.20
587504	RESORT DE RAPPEL 15X88 MM	15x88mm	8.00
589519	BOULE 6MM TIGE A CCELERATEUR	6mm	6.20
589519A	ROTULE SP M5 TRINGLE COMM- GAS	5mm	7.80
590006	AXE PAPILLON CARB 32PBIC	Ø8,5x88mm	53.10
590006A	AXE PAPILLON CARB 35FPAI	Ø8,5x102mm	39.80
590006Z	AXE PAPILLON CARB ZENITH	Ø8,5x97mm	55.70
820-S	GOUJON DE FIXAT DE CARBURATEUR	M8x44	1.00
89329	VIS TUBULURE SILENCIEUX ADMR		4.10
S32PBIC	CARBURATEUR SOLEX 32 PBIC	32 mm	214.70

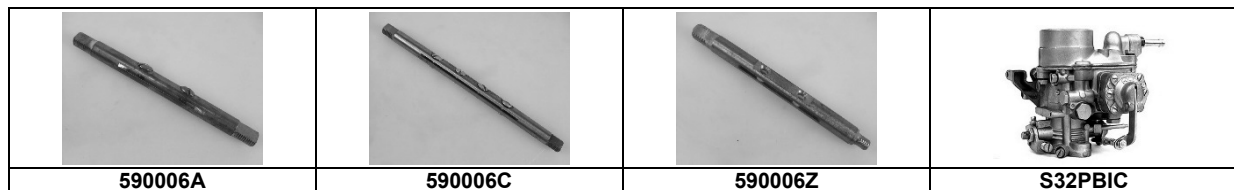
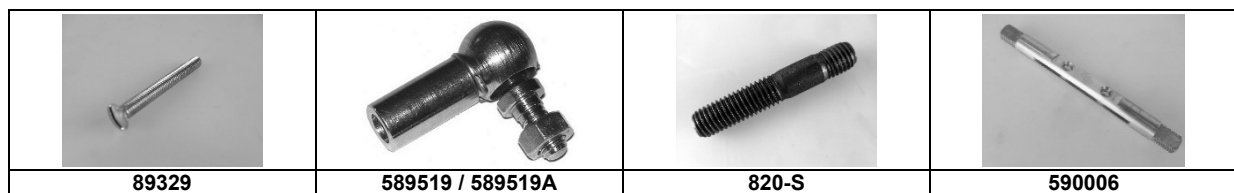
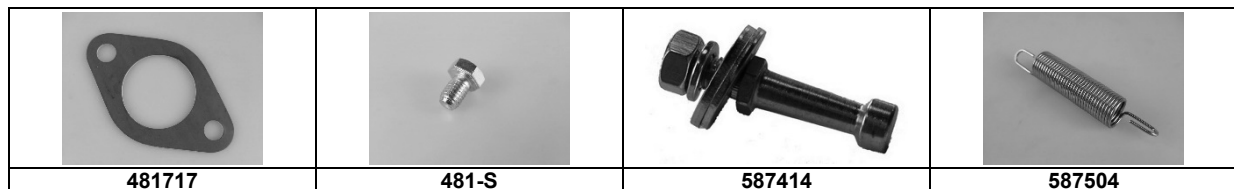
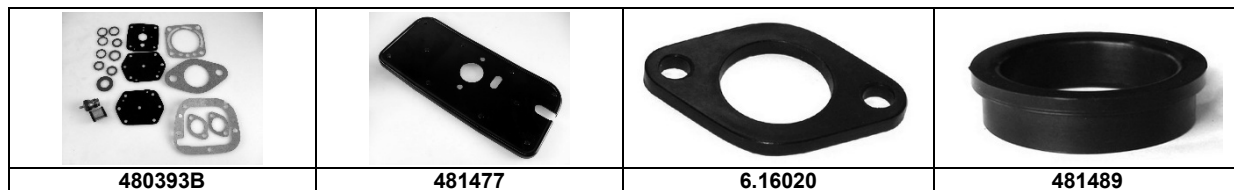
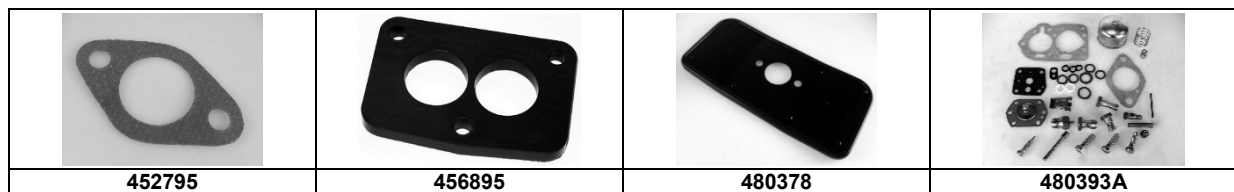

## CARBURATEUR FILTRE AIR

No d'article	article		Prix CHF
S34PBIC	CARBURATEUR SOLEX 34 PBIC	34 mm	199.80
SN3150	CARBURATEUR POINTEAU	1.5	11.30
481482S	FILTRE A AIR STICKER	95x45mm	5.40
481510M	ECROU FILTRE A AIR SUPERIEUR	M7xØ25x10mm	5.70
481510S	FILTRE A AIR STICKER MIOFILTRE	95x45mm	5.40
481511A	CARTOUCHE FILTRE ROND	Ø175x60mm	21.80
481516	CARTOUCHE FILTRE VOKES ECROU	280mm	47.30
481517/8	JOINT CAOUTCHOUC FILTRE A AIR	Ø10x95cm	9.50
481568	RACC COLL. FILTRE A AIR/CARB	Ø85x26x52mm	9.30
481598	CARTOUCHE FILTRE VOKES CLIP	230mm	33.90
481670A	JOINT CAOUTCHOUC FILTRE A AIR	Ø10x124cm	5.00
481670M	ECROU FILTRE A AIR SUPERIEUR	M7xØ25x6,5mm	6.30
481720	CARTOUCHE FILTRE ROND	Ø175x50mm	18.80
619087	RONDELLE SOUS ECROU DE FILTRE	9x28x1mm	0.90
D171-4	RACC FILTRE A AIR/COUVRE-CUL.	80x86x38mm	9.50
D171-94/95	RONDELLE ELAST. INF/SUP FILTRE	9x28mm	5.10
480010	FILTRE A AIR 52 UNIVERSAL	Ø138mm	48.90
709677	RACCORD CAOUTCH TUBE DERESSION		4.40
6.16037	FLOTTEUR CARBURATEUR SOLEX		18.50
6.08036	POCHETTE JOINTS CARB ZENITH 36		25.70
6.08035	POINTEAU 2 MM POUR CARB SOLEX 35 / 34		11.50
590003	JOINT VIS SERRAGE DE LA CUVE	O6,3x12mm	0.20

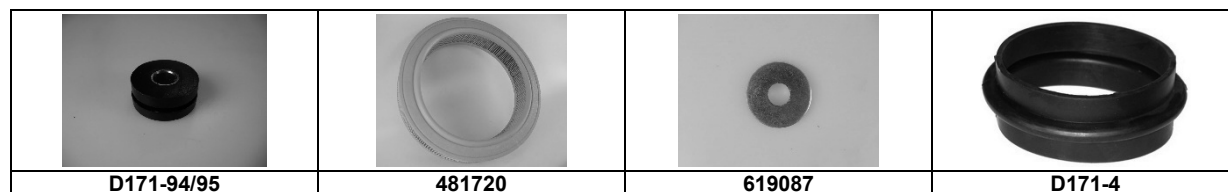
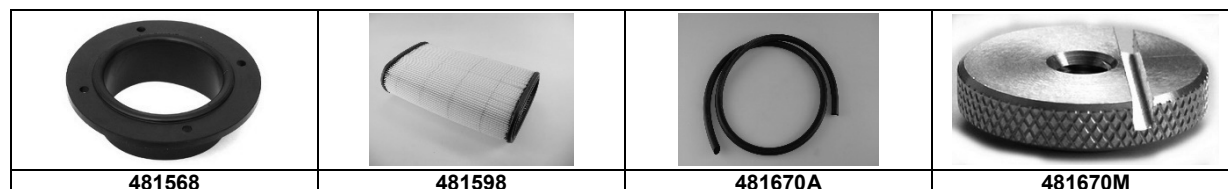
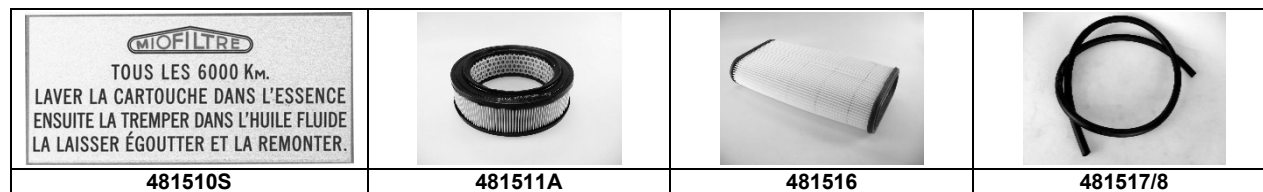
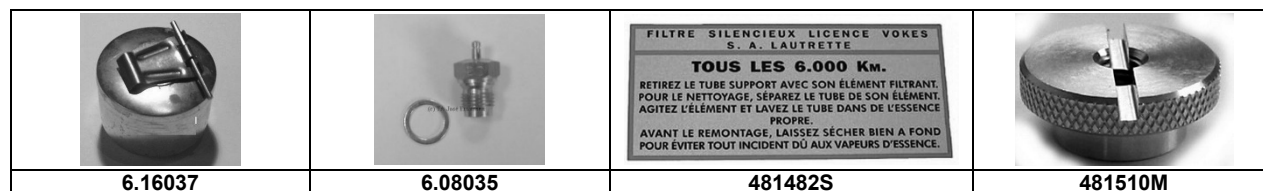
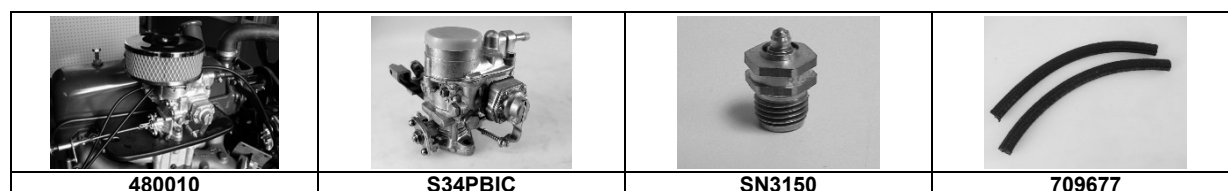

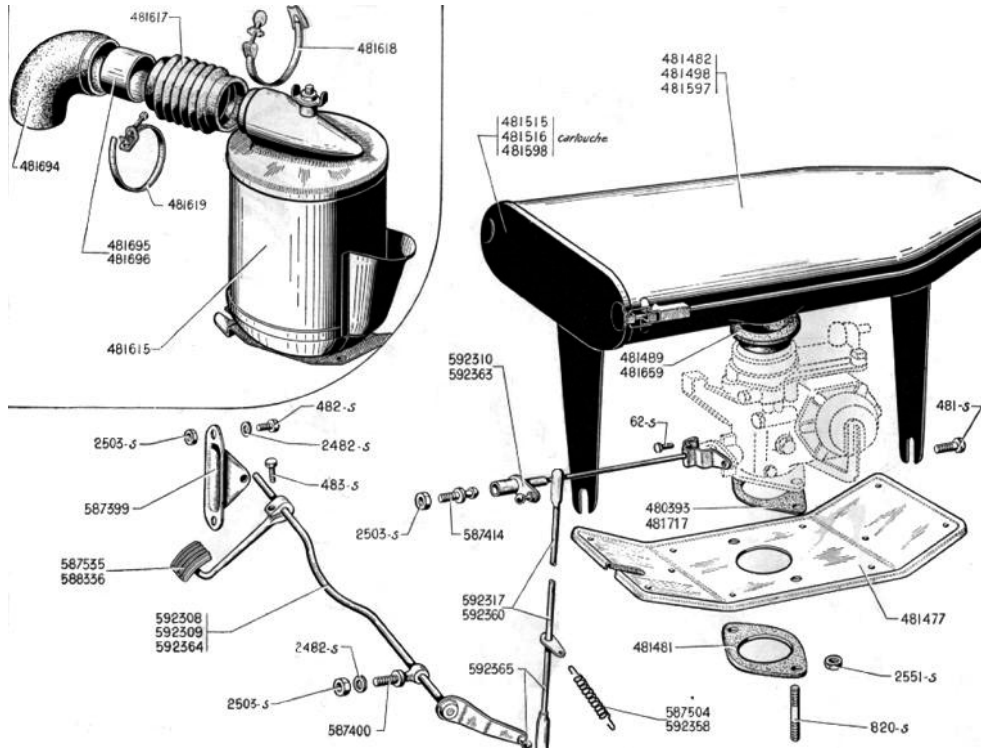

### ALLUMAGE

No d'article	article		Prix CHF
11030	BOBINE 12V		64.10
709400	BOBINE 6V		90.50
453173	REBOITAGE DISTRIB. 2 O-RING	62x40mm	27.00
457388	BOUGIE EYQUEM C 42 S	M14	5.30
543371	RESSORT RAPPEL LEV COM.DISTRIB	11x126mm	7.00
586792BH	TIRETTE DE DEPART	Ø22x15mm	23.40
586796B	TIRETTE DE DEMARREUR	Ø22x4,5mm	23.40
709136	ROTOR DU DISTRIBUTEUR RB PETIT	Ø14,3x16	18.70
709140-2	RUPTEUR ALLUMAGE		18.30
709178	ROTOR DISTRIBUTEUR SEV (PETIT)	Ø14,4mm int.	22.00
709179	ROTOR S.E.V GRAND	Ø14x25mm	10.30
709192	TETE DU DISTRIBUTEUR SEV	Ø58,5mm ext.	36.30

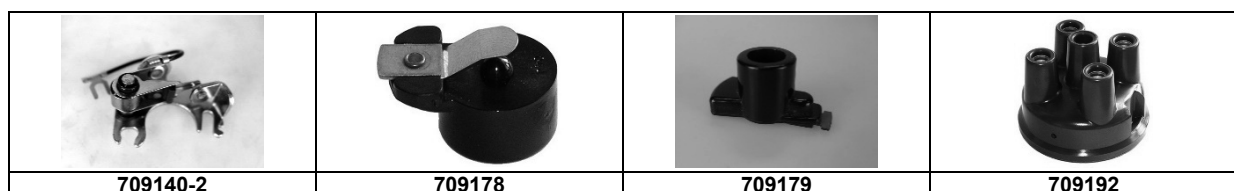
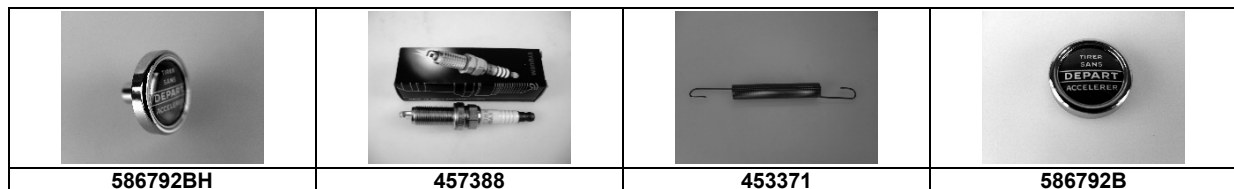

## ALLUMAGE

No d'article	article		Prix CHF
709193	TETE DU DISTRIBUTEUR SEV	-	69.80
594806	CONDENSATEUR DUC D703	17x38,5mm	8.20
709250	ROTOR DU DISTRIBUTEUR D(PETIT)	-	17.60
709251	TETE DUCELLIER D807	Ø65mm int.	12.00
709398M	BOBINE SUPPORT	-	8.60
709647	CONTACT JEU RUPTEUR DUC (2229)		66.40
709648	CONTACT JEU RUPTEUR SEV (2286)		23.00
709670	CONTACT JEU RUPTEUR DUC (2289)		14.20
709671	CONTACT JEU RUPTEUR DUC (2215)		21.00
709676	TUBE DE DEPRESSION DE	3x4.5mm, L=70cm	45.50
709677	RACCORD CAOUTCH TUBE DEPRESS.	2x125mm	4.40
709677T	TUYAU VACUUM RACCORD-T	5mm	18.60
709700	CONTACT JEU RUPTEUR DUCELLIER		36.80
709705	CONTACT JEU RUPTEUR DUC 2213		26.40
709727	CONTACT DE RUPTEUR SEV S403		11.40
709800	DISTRIBUTEUR ALLUMAGE + VACUUM	-	199.00
715024	JEU CABLE DE BOUGIE	5 Stk/piece	41.90
723160DH	BOUTON TIRETTE DEMARR D HOR	11,6x31mm	7.40
723160DV	BOUTON TIRETTE DE DEMARREUR	11,6x31mm	7.40
723160SH	BOUTON TIRETTE DE STARTER	11,6x31mm	7.40
723160SV	BOUTON TIRETTE DE STARTER	11,6x31mm	7.40

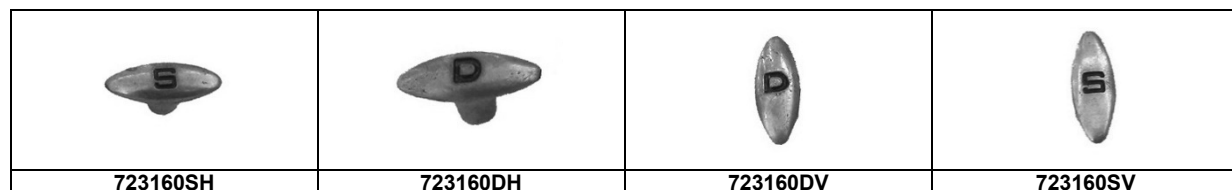
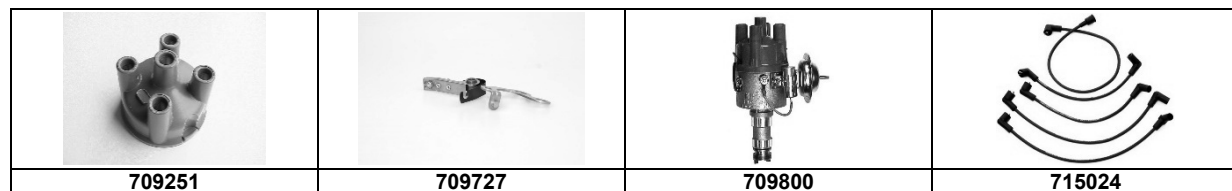
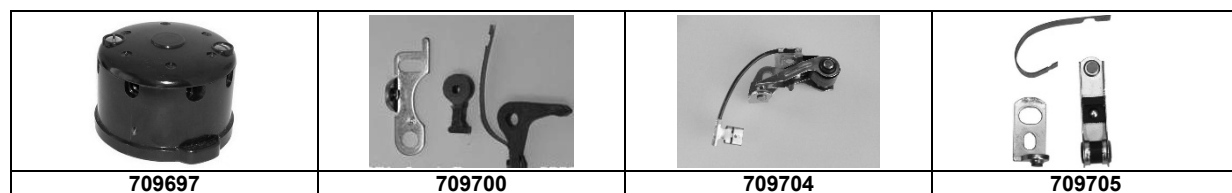
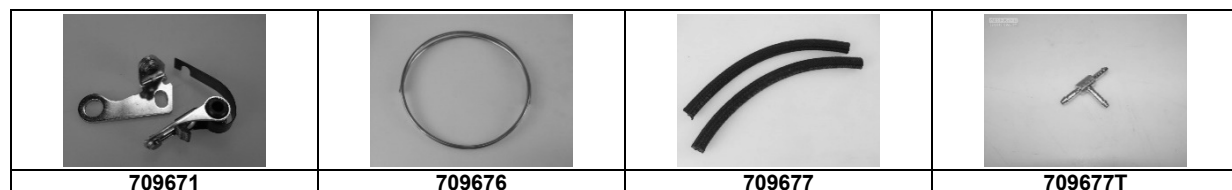

## ALLUMAGE

No d'article	article		Prix CHF
723171	TIRETTE DE STARTER	81 cm.	18.70
723221	COMMUT ALLUMAGE SANS BARILLET	20mm	53.90
9504400	REMBOTAGE DISTRIBUTEUR O RING	26,2x3,6mm	1.20
9504900	REMBOTAGE DISTRIBUTEUR O RING	31,8x1,9mm	1.20
DM211-17	CONTACTEUR DUC D304		8.50
594806	CONDENSATEUR DUCELLIER D703		7.40
709249	ROTOR DUC SORTIE VERTICAL	Ø14,3 int.	16.90
5508170	ROTOR DUCELLIER D911		8.80
709005	ALLUMEUR ELECTRONIQUE 6 12 V DEPRESSION		599.00
6.40270	ALLUMEUR ELECTRONIQUE 6 12 V SANS DEPRES		488.00
723155	TIRETTE DE DEMARRAGE OVAL		29.80

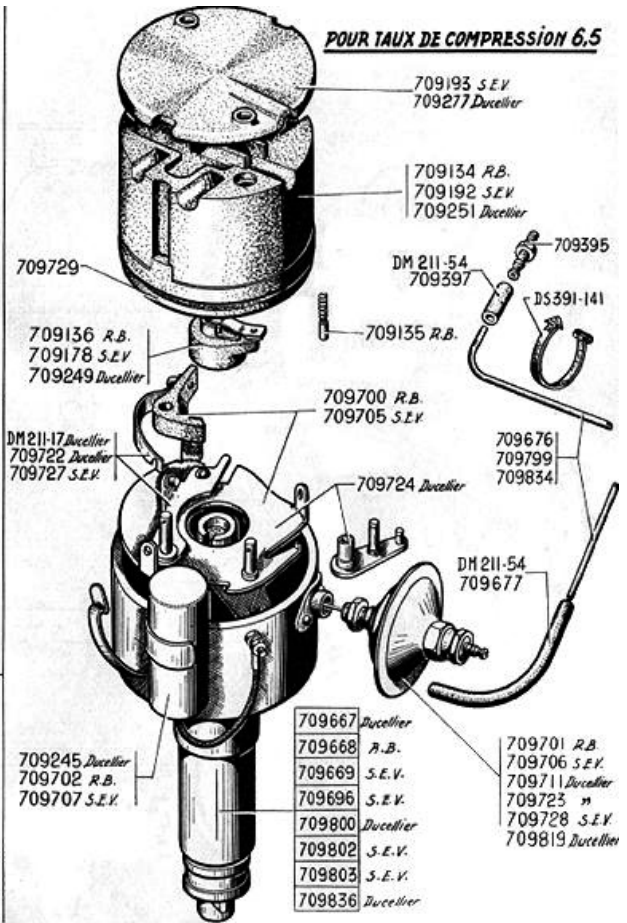
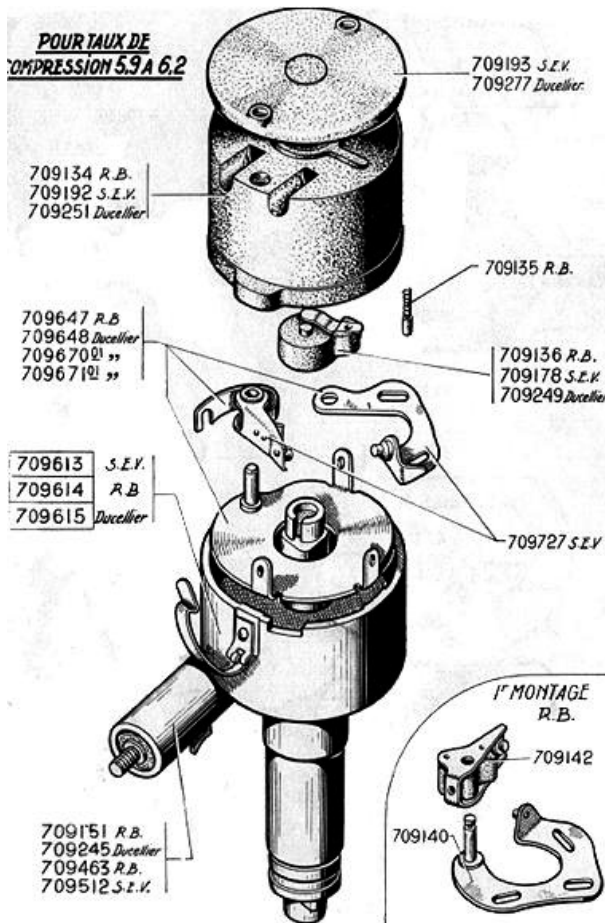
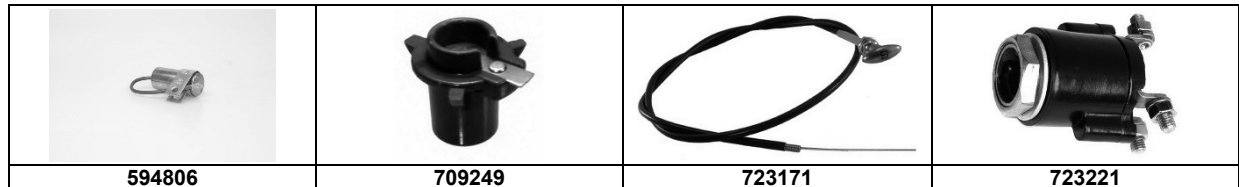

Février 50 / Avril 52

592322  
723093  
723100



démarréur  
723067  
723111  
723155  
starter  
330277  
723171

Depuis Avril 52

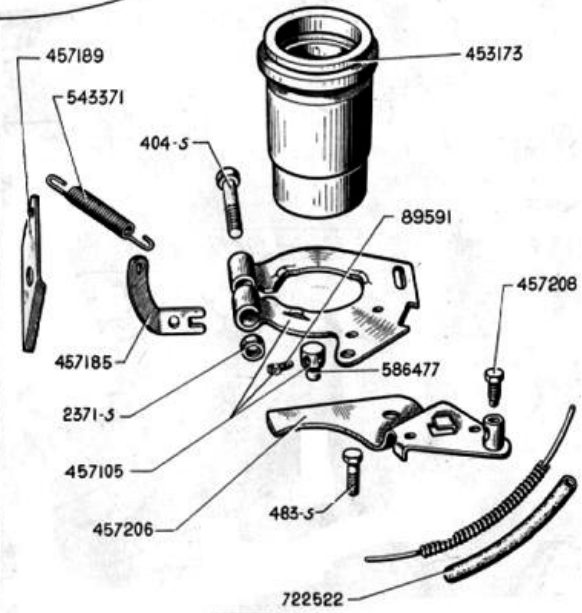
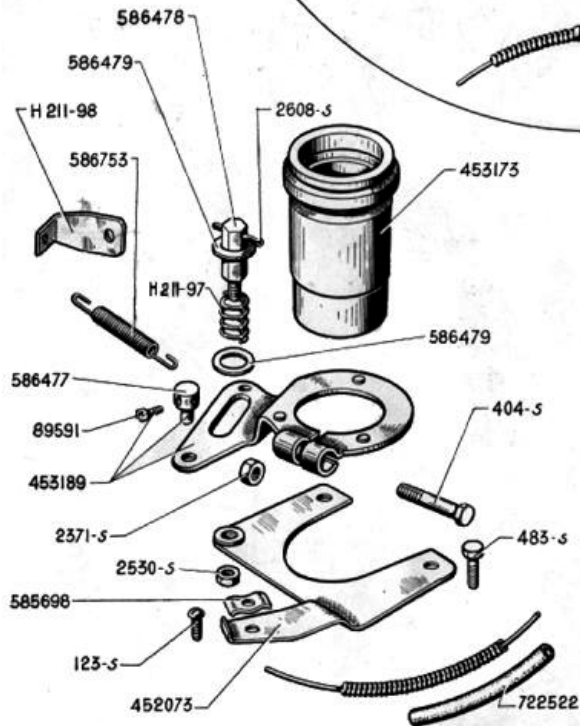



**Kontaktsatz Ducellier:48 DM 211-17**



**Kontaktsatz S.E.V.:48 709.727**



**Kontaktsatz Ducellier 709647**



**Kontaktsatz S.E.V 709648**



**Kontaktsatz Ducellier:48 709.670**



**Kontaktsatz Ducellier:48 709.671**



**Kontaktsatz R.B.:48 709.700**



**Kontaktsatz R.B.:48 709.705**



**Kontaktsatz Ducellier:48 709.722**

## ECHAPPEMENT

No d'article	article		Prix CHF
1000-S	GOUJONS TUBE AV COLLECTEUR	M10x40mm	1.90
308324	JOINT METAL. DU TUBE VERTICAL	Ø53x65mm	8.80
308328W	TUBE SOUS COQUE 2 PIECE BN BL		89.10
308334	TOLE PROT ALTERN/ECHAPPEMENT	157x80mm	35.00
308431	JOINT BRIDES TUBE SS CAISSE	höhe 70mm	7.00
308553	TUBE VERTICAL ECHAPPEMENT	Ø48x1050mm	167.40
308698	TUBE VERTICAL ECHAPPEMENT	Ø48x1100mm	152.70
309178	PLAQUETTE ELASTIQ TUBE SORTIE	64x30mm	6.50
309183	EQUERRE ASSEMBLEE TUBE SORTIE	190x35mm	28.50
309189/7	SUPP TUBE SS COQUE SORTIE 42MM	116x38mm	36.10
309278	ECROU TUBE AV SUR COLLECTEUR	M10x150, H20	6.10
309293	EQUERR ASS TUBE SS CAISSE/TRAV	110x40mm	24.00
310174	ENTRETOISE MAINTIEN TUBE VERT	553x30mm	57.20
310175	ENTRETOISE MAINTIEN TUBE VERT	608x30mm	57.20
321078	PLAQ ELASTIQUE TUBE SS CAISSE	95x30mm	5.40
321121	POT ECHAPPEMENT +TUBE SORTIE	Ø11,5x55cm	155.30
321195	PLAQUETTE CAOUTCH TUBE SORTIE	105x30mm	5.90
321214	COLLIER INF TUBE SORTIE 38MM	116x38mm	27.70
321216	PLAQUETTE CAOUTCH TUBE SORTIE	95x30mm	7.50
940-S	JEU VIS BRIDE DBLE TUBE SS COQ	M10x35	5.20
310175P	ENTRETOISE MAINTIEN TUBE VERT PERF		61.30
290004	ROBRI ENJOLIVEUR ECHAPPEMENT		94.50

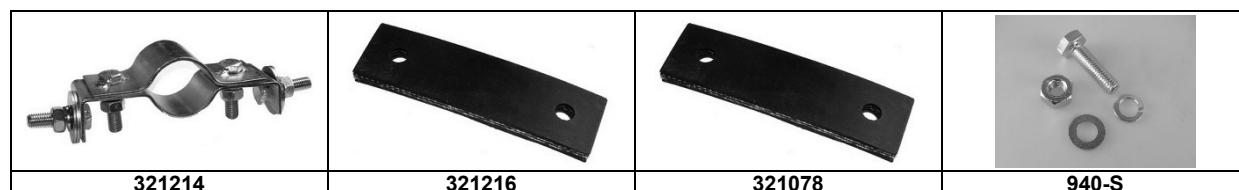
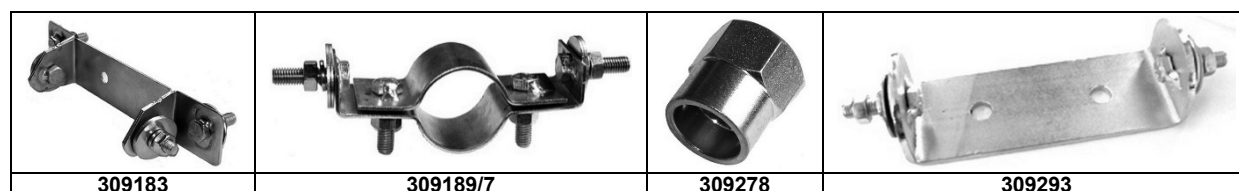
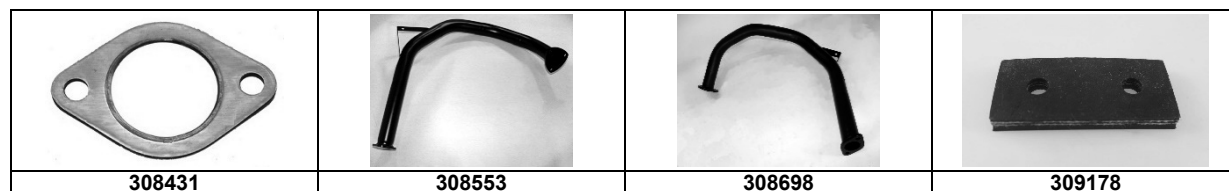

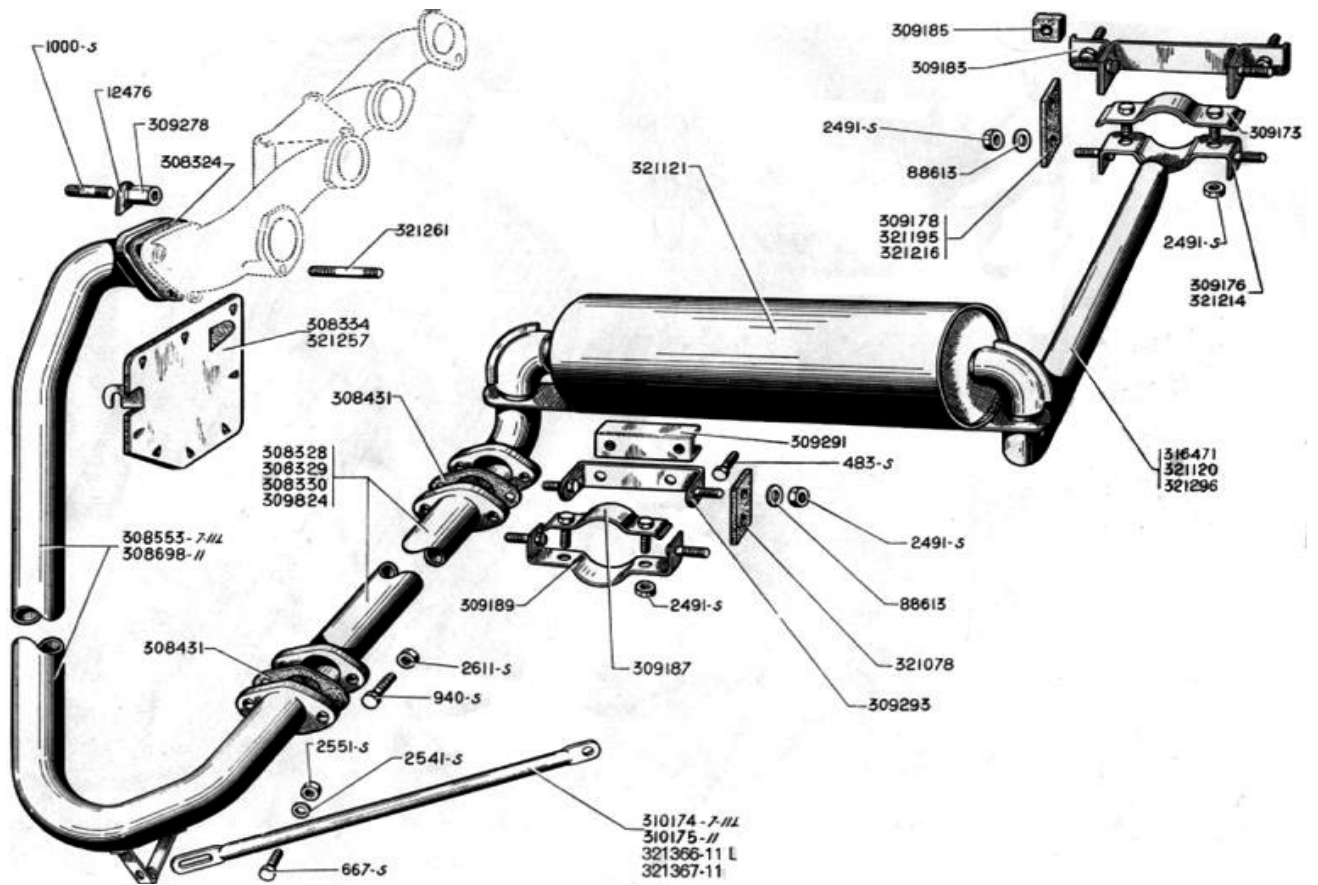

### SUSPENSION MOTEUR

No d'article	article		Prix CHF
452081	CA OUTCHOUIC COUP. LATERALE D+G	75x64x6mm	3.40
452083	COUPELLE RESSORT LATERAL 65MM	Ø69x21mm	19.00
452395	BAGUE CONIQUE CA OUTCH BOITE	38x48mm	10.70
454070	BUTEE AR SUSPENSION MOTEUR	82x30mm	48.60
457243	COUPELLE RESSORT LATERAL 69MM	Ø65x21mm	18.90
457244	RESSORT DE MAINTIEN D/G	Ø60x60mm	52.00
457244A	RESSORT DE MAINTIEN D/G	Ø65x58mm	52.00
457244GB	RESSORT DE MAINTIEN D/G	Ø65x65mm	48.00



## SUSPENSION FLOATING

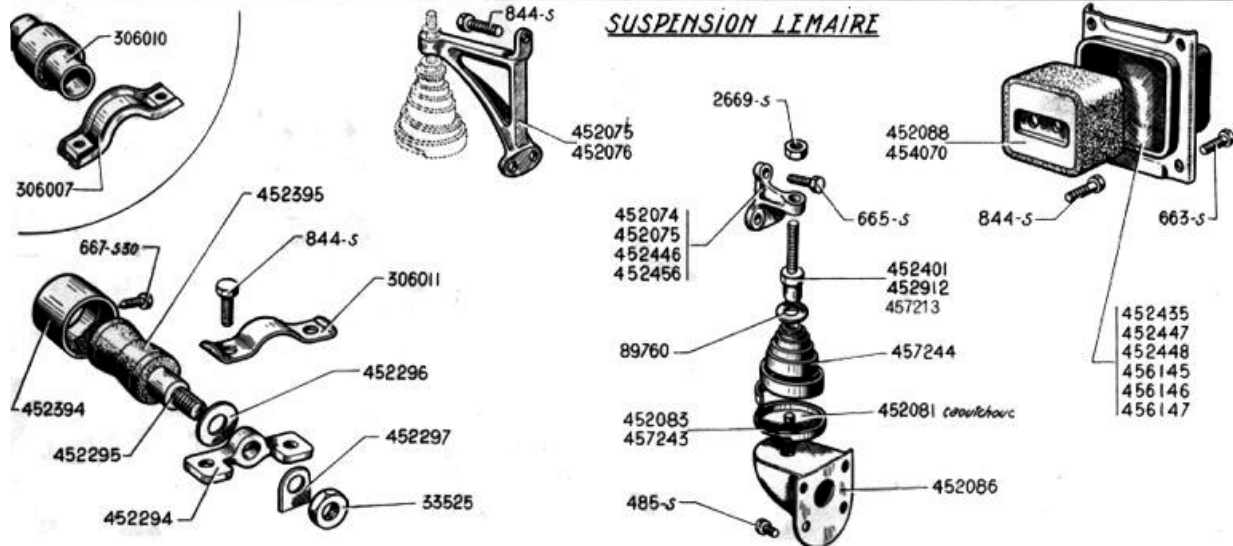
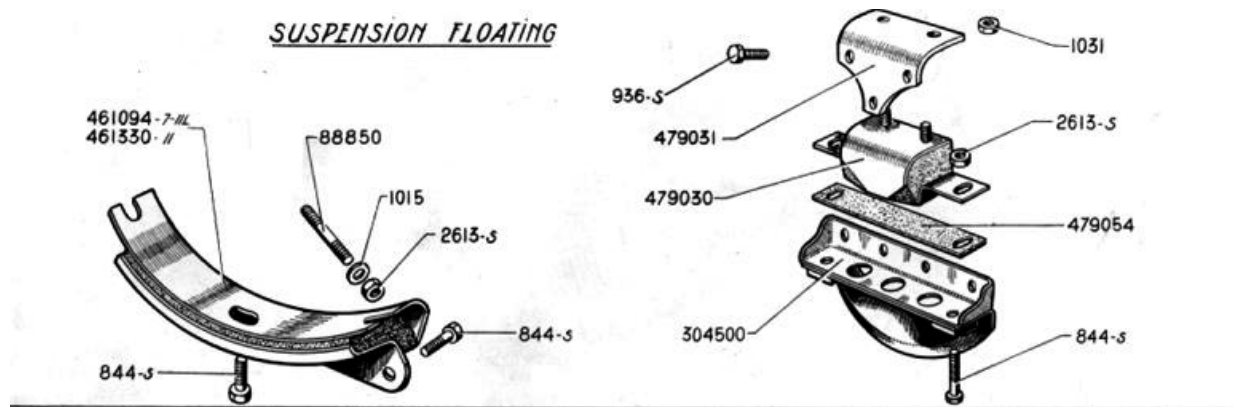





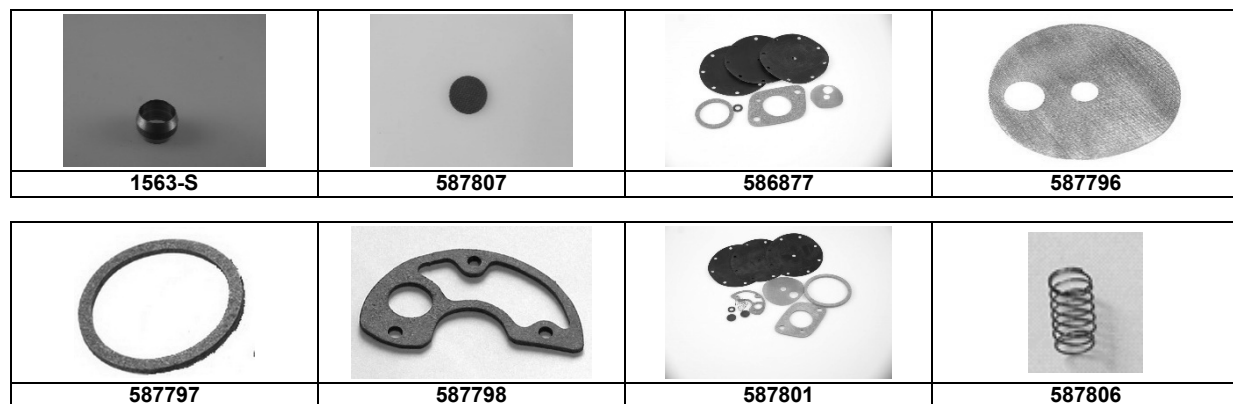











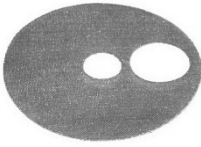



## POMPES ESSENCE

No d'article	article		Prix CHF
1563-S	TUYAU ESSENCE BICONE	8mm	5.00
586877	JEU REP POMPE ESSENCE GUIOT	Ø91mm	18.20
587796	FILTRE CUVE POMPE ESSENCE SEV	Ø67mm	6.00
587797	JOINT CUVE POMPE ESSENCE SEV	65x75x3mm	3.20
587798	JOINT PLAGUE RESS SOUPAPES SEV	-	3.20
587801	JEU REP POMPE ESSENCE SEV	Ø102mm	18.20
587806	RESSORT DE SOUPE SEV	Ø9mm	1.60
587807	SOUPE POMPE ESSENCE SEV	Ø14x1mm	4.10



## POMPES ESSENCE

No d'article	article		Prix CHF
590005	CLAPET ANTIRETOUR ESSENCE	2x8mm	30.30
6.08515	FILTRE A ESSENCE PETIT	2x Ø8mm	2.80
590008	PROT. CHAUFF. POMPE ESSENCE	29x16,5cm	46.00
595002	VIS POUR CUVE EN VERRE GUIOT	M6x35mm	0.90
595003	JOINT COUP POMPE ESSENCE GUIOT	35x45x2mm	2.20
595004	FILTRE CUVE POMPE ESS. GUIOT	Ø41mm	5.60
595022	JOINT ENTRE POMPE ET CYLINDRE	per Stk.	3.00
595326	CUVE EN VERRE POMP ESSENCE SEV	Ø73mm	25.70
595329	VIS CUVE VERRE POMP ESS. SEV	M6x34mm	12.60
595335	CUVE VERRE POMP ESSENCE GUIOT	Ø45mm	12.80
595337V	RESSORT LEVIER POMPE ESS. SEV	-	3.00
595339V	RESSORT LEVIER POMPE ESS. SEV	-	3.40
6.08504	TUBE CA OUTCHOUC ESSENCE	Ø6mm	12.90
595345B	COLLIER TUYAU ESS.	15mm	1.00
595345T	RACCORD-T TUYAU ESSENCE		18.70
595822	POMPE D ESSENCE	-	67.20
595822A	POMPE ESSENCE AVEC VERRE	-	140.00
6.08195	ELEV A TEUR ESSENCE	2x8mm	48.00
721440	POMPE ESSENCE ELECTRIQUE	-	224.60
6.08508	TUYAU ESSENCE 8 MM		14.70
6.08517	FILTRE D ESSENCE CHROME		16.10
6.08024	POMPE A ESSENCE METALIQUE		66.20
6.08026	POMPE A ESSENCE METALIQUE HORIZONTAL		98.60

			
6.08026	590005	6.08515	590008
			
6.08517	595003	595004	595022
			
595326	595345T	595335	595337V
			
595339V	6.08504 6.08508	595345B	595345T
			
595822	595822A	721410	721440

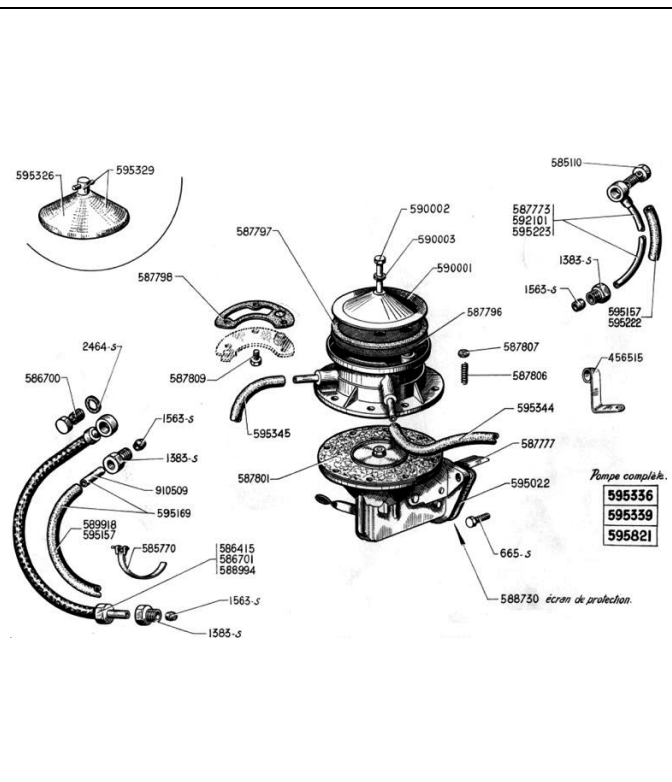
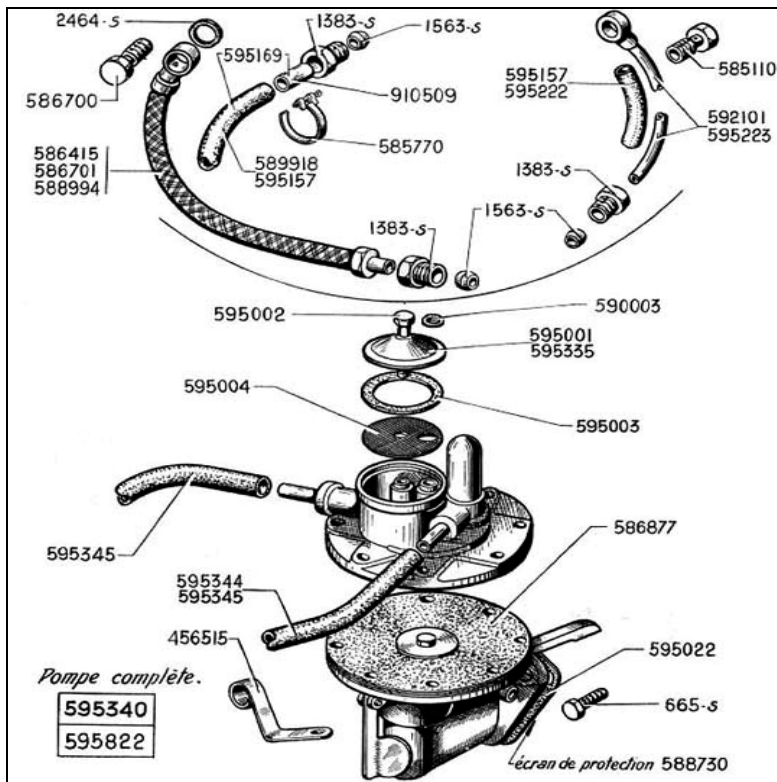

### RESERVOIR ESSENCE

No d'article	article		Prix CHF
1064-BB	CA OUTCHOUÇ GUIDE TUBE ESSENCE	46x25mm	14.30
221354	COLLERETTE CA OUTCH TUB. INT	O87x53x20mm	18.00
224186	COLLERETTE SUP. TUB RESERVOIR	O95x50mm	8.10
2464-S	JOINT DE BOUCHON	12x17x1mm	1.00
2470-S	JOINT METALL. BOUCHON VID EAU	12x17x2	1.20
6.90039	BOUCHON 2CV CHROME	O55mm	19.90
585770	COLLIER SERR FLEX ESSENCE 8MM	O14mm	1.50
586354	BOUCHON DE RESERVOIR	O65mm	40.50



## RESERVOIR ESSENCE

No d'article	article		Prix CHF
586354S	BOUCHON RESERVOIR ESS +SERRURE	O65mm	73.20
587047	BOUCHON DE VIDANGE +FILTRE	M20x150	51.30
587050	JOINT DE BOUCHON	20x26mm	2.40
587499	PATTE SIMPLE TUYA UTIERIES 8MM	32x15mm	1.00
588276	RESERVOIR ESSENCE	45Ltr 98x32cm	479.30
588278	RESERVOIR ESSENCE	50Ltr 106x32cm	497.20
589168	ECROU H SUPERIEUR DE PLONGEUR	M12x1,25	7.50
589169	PLONGEUR DE PRISE ESSENCE	205mm	65.70
6.08508	TUBE CAOUTCHOUC ESSENCE 8MM	O8mm	14.70
595362	BOUCHON DE VIDANGE	M12x1	8.90
595371	PLONGEUR DE PRISE ESSENCE	152mm	52.70
595376	FLEX CAOUTCH TUYAU/PLONGEUR	7x16mm	7.60
6.46201	JOINT CAOUTH RHEOSTAT+PLONGEUR	36X55X2m	2.80
723041	RHEOSTAT DE JAUGE ESSENCE	6 Volt	35.10
771-S	VIS SERRAGE SANGLES RESERVOIR	M8x70	1.40
6.91331	CAOUTCHOUC BOUCHON 2CV NOIR	O84x34mm	13.90
803684	RESERVOIR ESSENCE	50Ltr 35x102,5cm	459.00
803685	RESERVOIR ESSENCE	50Ltr 35x102,5cm	472.80
803884S	BOUCHON RES. ESS. VERR.	O55mm	59.40
910509	TUBE ESSENCE JEU 8MM	440cm	60.80
803716	JOINT CAOUTCH LOGEMENT RESERV		5.80

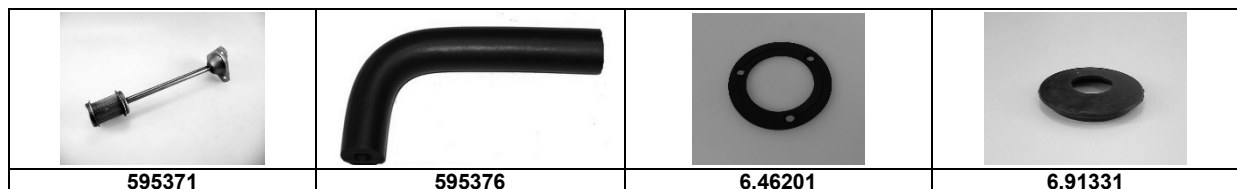
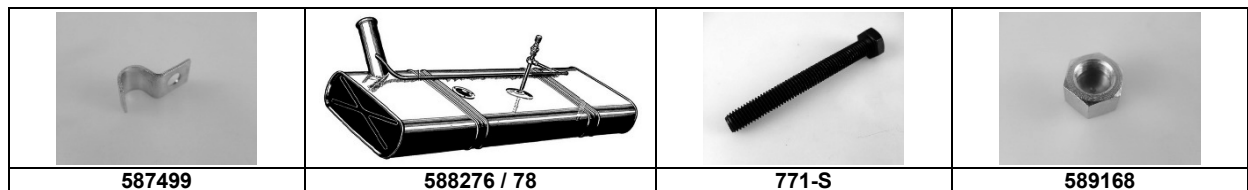
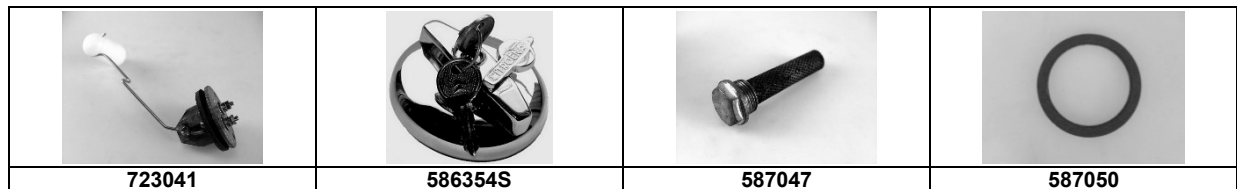

## RESERVOIR ESSENCE

No d'article	article		Prix CHF
803718	TOLE ETANCH +JOINT CAOUTCH		22.10
803884	BOUCHON 2CV CHROME		28.50
DM1755A	FLOTTEUR DE RESERVOIR		55.60
590003	JOINT VIS SERRAGE DE LA CUVE		0.20

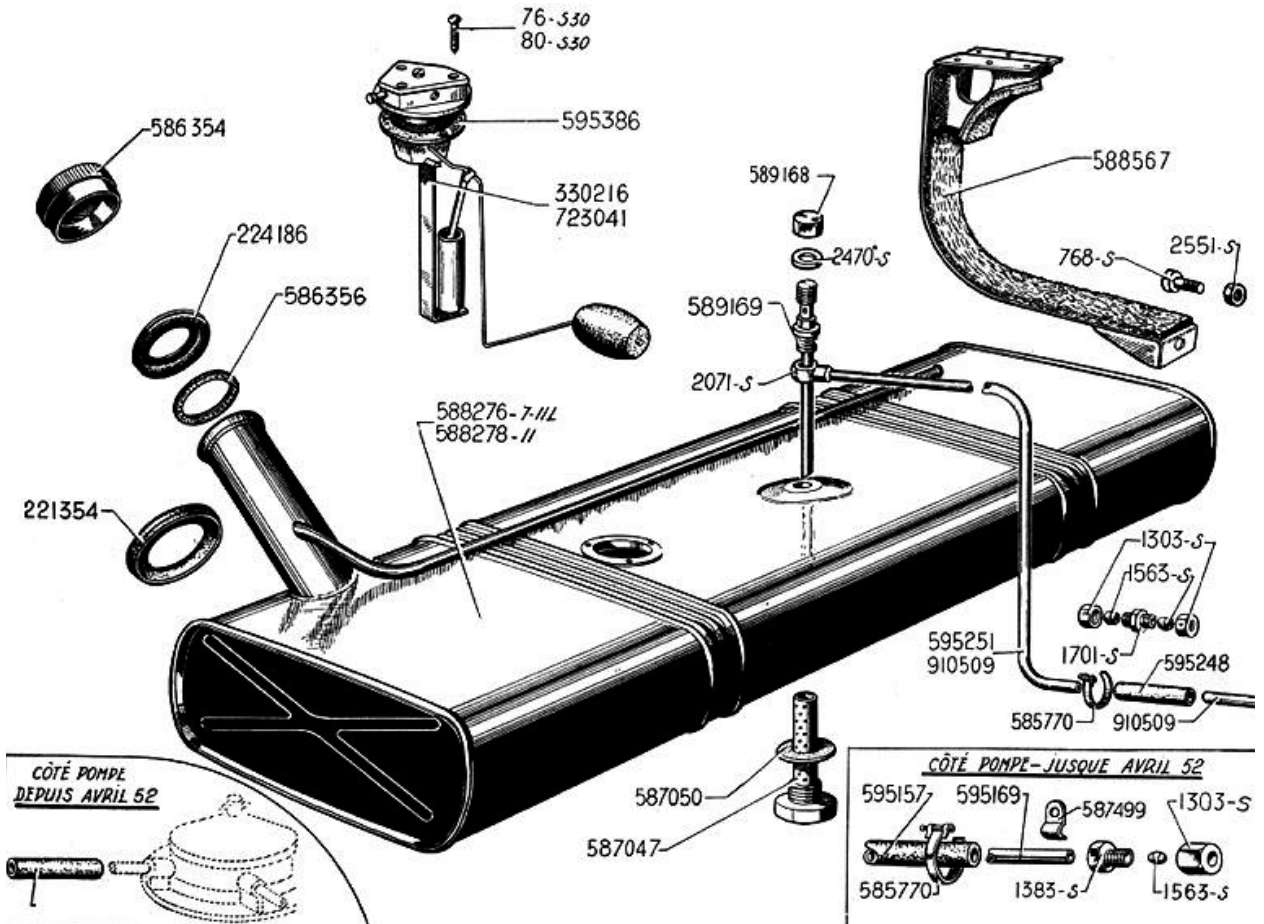

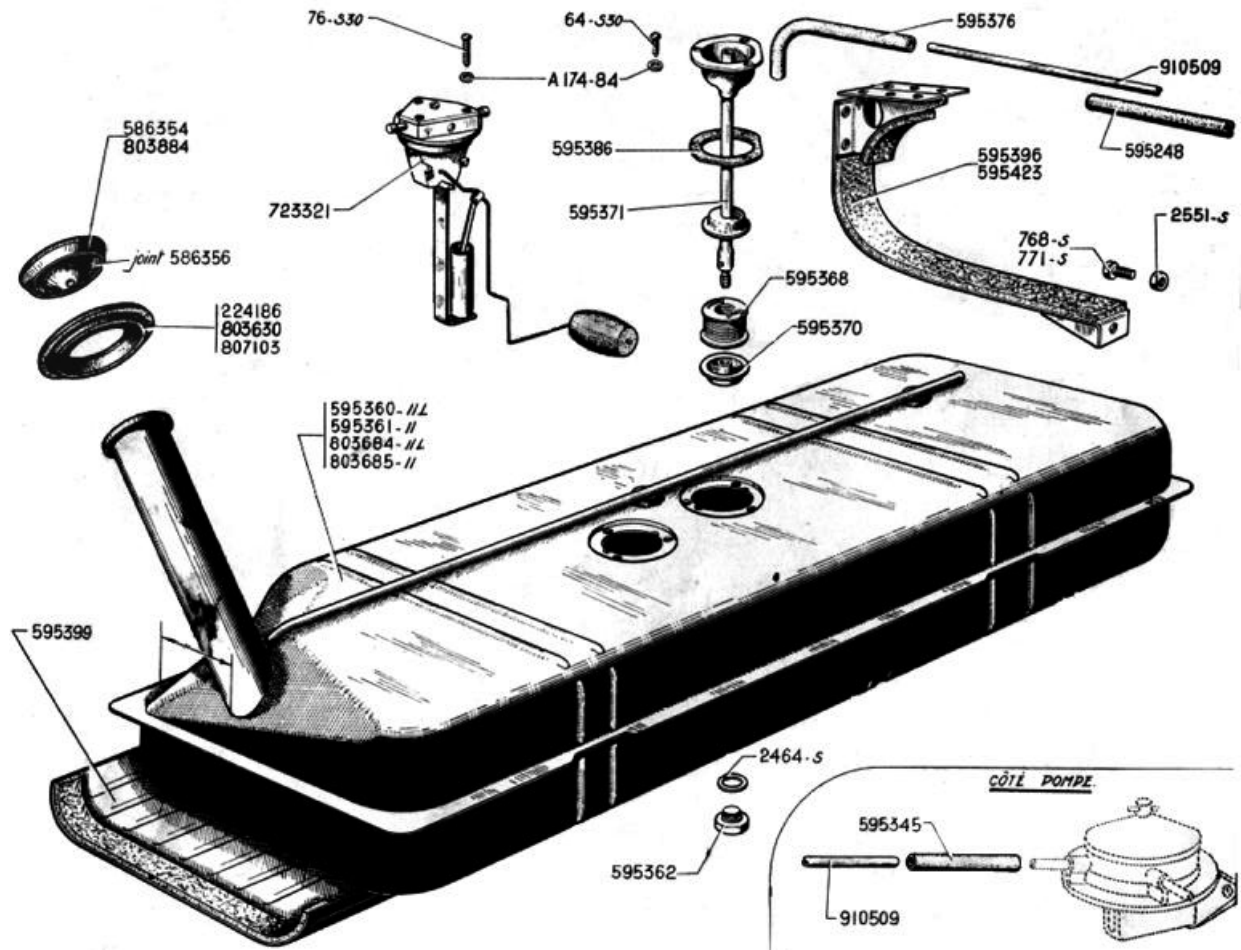





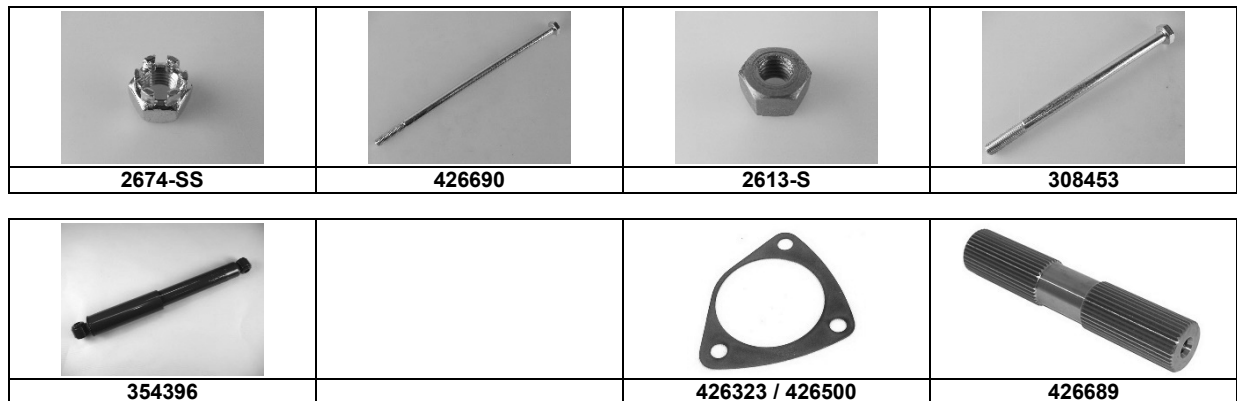





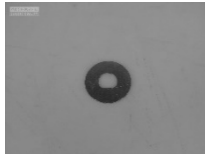







### TRAIN AVANT

No d'article	article		Prix CHF
2674-SS	ECROU CREMAILLER/BARRE DIR.	M12x175	5.70
354396	AMORTISSEUR AVANT GABRIEL		79.70
426323	CALE REGL SILENTBL EPAIS 0.7MM	0,70mm	8.00
426500	CALE REGL SILENTB EPAIS 0.95MM	0,95mm	10.60
426689	ARBRE A CANNELURES	Ø32x175mm	154.50
426690	VIS DE BARRE DE TORSION	8x192mm	5.20
2613-S	ECROU BOULONS SUPP BRAS/TRAVER	M10x150	1.00
308453	VIS SUPPORTS BRAS SUP/TRAVERSE	10x175	12.10
426198A	COUPELLE MOBIL ROTULE BRAS INF	45/60mm	36.50

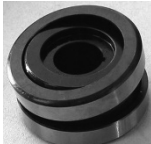

## TRAIN AVANT

No d'article	article		Prix CHF
426409	CONTRE-ECROU BOUCHON BRAS SUP.	64x6,5mm	16.20
426440	BAGUE ENTRETOISE DE BRAS SUP.	Ø22x16x52mm	29.30
426531	ECROU ROTULE SUP.	M16	10.80
426568	ARRETOIR BAGUE AV DE BRAS SUP.	35,5mm	8.40
426569	AXE BRAS SUP +DOUILLE BRONZE	22x264mm	115.10
426569A	AXE BRAS SUP. AVEC SILENTBLOC	22x264mm	143.50
426576	EPAISSEUR 0.3MM	-	0.80
426576A	EPAISSEUR 0.5MM	-	0.80
426576B	EPAISSEUR 1.0MM	16x22x1mm	0.80
426581	ARRETOIR ECROU AXE BRAS SUP.	36x14,2mm	3.50
426607	ROTULE SUSPENSION SUP	Ø52mm	121.50
426608	ARRETOIR DE CONTRE-ECROU SUP.	66/55mm	6.10
426613	ROTULE SUSPENSION INF	Ø60mm	110.20
426615	ECROU ROTULE INF	M16	12.70
426618	FUSEE MANCHETTE CA OUTCHOUC	Ø76x20xO22mm	9.30
426618A	FUSEE MANCHETTE CUIR INF 68MM	Ø68mm	28.40
426618B	FUSEE MANCHETTE CUIR SUP 62MM	Ø62mm	28.40
426620	RESSORT DE ROTULE	19x25,5x29,5mm	4.10
426623	SEGMENT DE BLOCAJE DE COUPELLE	63x69x3	3.90
426662	ECROU BOUCHON DE BRAS SUP.	54mm	17.90
426663	ROND. ECROU BOUCHON BRAS SUP.	44mm	12.00
426664	BUTEE CA OUTCHOUC DE BRAS INF.	62x40mm	14.20

			
<b>426581</b>	<b>426607</b>	<b>426198A</b>	<b>426409</b>
			
<b>426440</b>	<b>426531</b>	<b>426568</b>	<b>426569</b>
			
<b>426569A</b>	<b>426576 / A / B</b>	<b>426662</b>	<b>426663</b>
			
<b>426608</b>	<b>426613</b>	<b>426615</b>	<b>426618</b>
			
<b>426618A</b>	<b>426618B</b>	<b>426620</b>	<b>426623</b>

## TRAIN AVANT

No d'article	article		Prix CHF
426667	CALE REGLAGE ROTULE PALIER INF	45x60x0,5	2.50
426676	ROTULE INF. STADE 1 BIS	Ø60x37mm	290.70
426720	RONDELLE DES ROTULES		0.70
426857	RONDELLE REP. MANCHON BRAS INF	60x72mm	6.80
844-S	VIS ENTRETOISE TOLE TRAVERSE	M10x20	3.00
88103	CLAVETTE LEVIER SUP. 2IEME/PD	2,5x12,5x5,15mm	5.70
88140	GLAVETTE DE FUSEE	2,5x3x12mm	2.00
88298	ECROU BLOCAJE AXE DE BRAS SUP.	M14x150	1.70
89847	RONDELLE ELASTIQUE CHARNIERES		0.90
426203	RONDELLE EPAIS 0.1 EN BAS		2.20
426567	ECROU TRIANGLE BRAS SUB		8.80

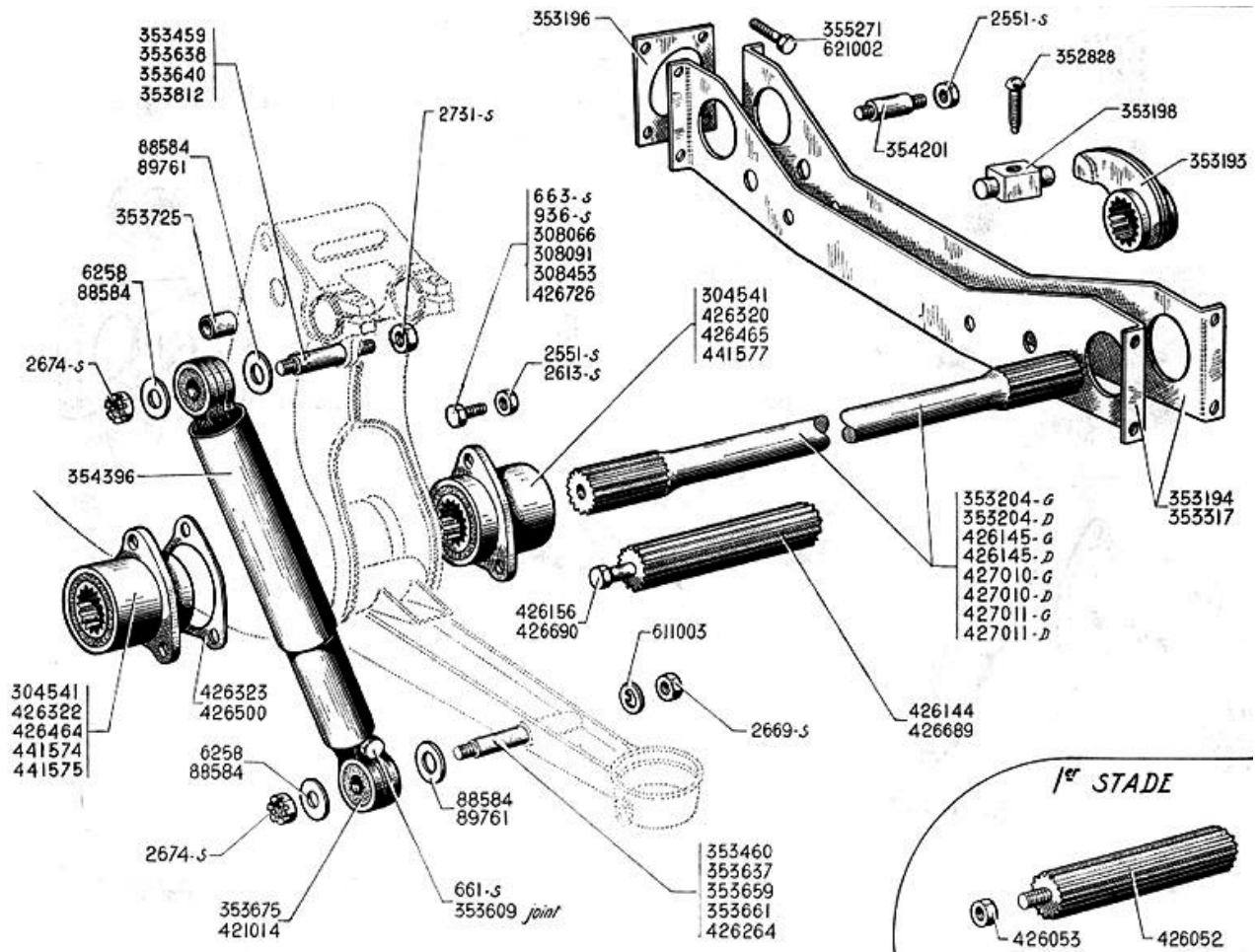
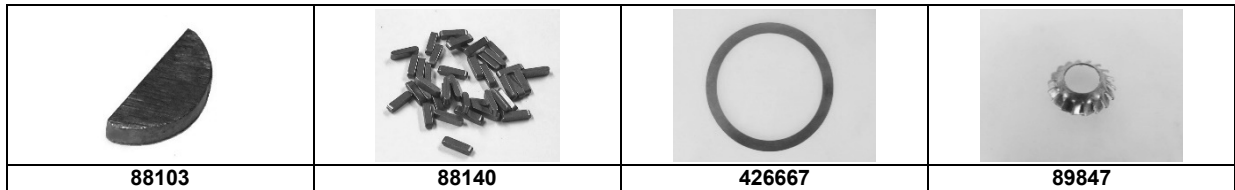
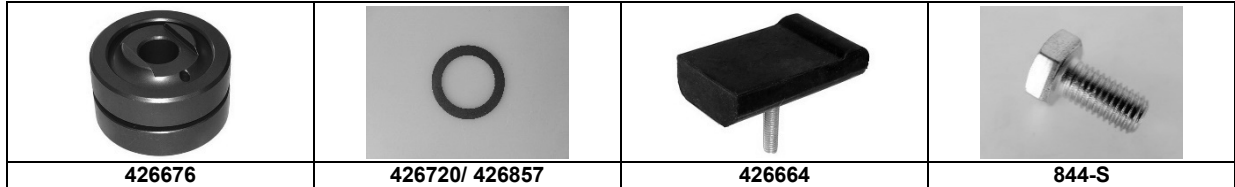



			
420931	420932	420933	620936
			
420953	420967	421009	421014
			
421356	421363	431300	431300R
			
441584	771-S	815-S	89894

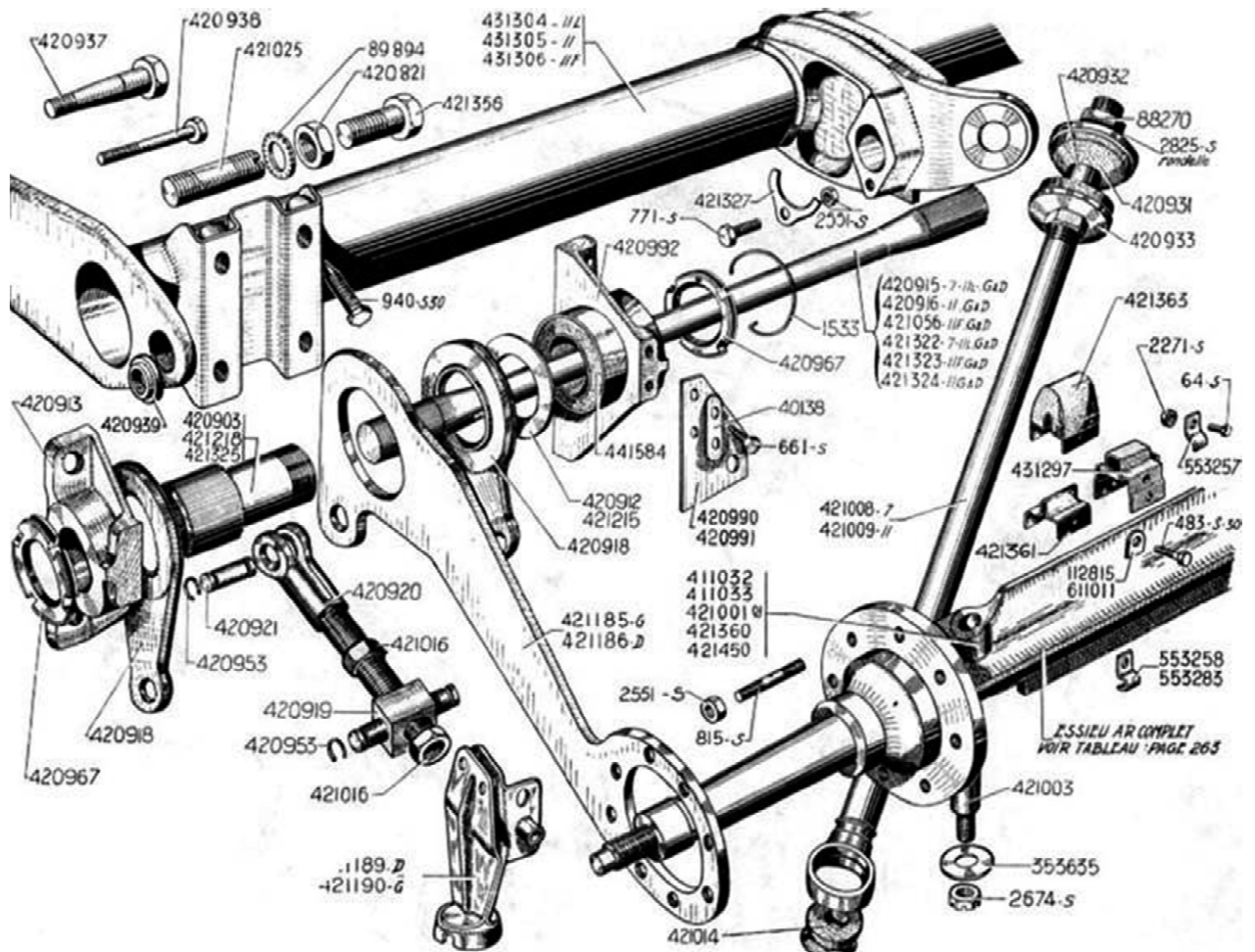

## TRANSMISSIONS ET FUSEES

No d'article	article		Prix CHF
380655	CHAP FEUTRE ETANCH CARDAN CPL	O40x16mm	17.10
381073	AXE ROTULE COTE ARBRE TRANSM	14,1mm	42.20
42650DLL	ARBRES HOMOC. DOUBLE G FIL D	670mm	750.00
42650DLR	ARBRES HOMOC. DOUBLE D FIL G	670mm	750.00
42650DNL	ARBRES HOMOC. DOUBLE G FIL D	725mm	750.00
42650DNR	ARBRES HOMOC. DOUBLE D FIL G	725mm	750.00
42650ELL	ARBRES HOMOC. SIMPLE G FIL D	600mm	499.50
42650ELR	ARBRES HOMOC. SIMPLE D FIL G	600mm	499.50
42650ENL	ARBRES HOMOC. SIMPLE G FIL D	660mm	588.60
42650ENR	ARBRES HOMOC. SIMPLE D FIL G	660mm	588.60
441270	CAOUTCHOUC TRANSMISSION PETIT		35.80
441270H	PROT CAOUTCH ARBRES HOMOC. EXT		57.60
441270HB	PROT CAOUTCH ARBRES HOMOC. INT	O24xO77	58.10
441304	ECROU DE VIS FIXAT CARDAN 10MM	10x150	3.60
441369	MANCHON TOLE PROT TRANSMISSION	92x87	18.00
441370A	CAOUTCHOUC TRANSMISSION LONG		15.80
441720	CROISILLON JOINT DBLE AIGUILLE	75x27mm	87.00
441721	ENS. CROISILLON CARDAN INTER	60x27mm	34.30
426591	ECROU BLOPAGE MOYEU AV FUSEE G	26x150	14.90
426592	ECROU BLOPAGE MOYEU AV FUSEE D	26x150	20.30
380956	CLAVETTE MOYEU-TAMBOUR	6mm	4.30
4750-S	GRAISSEUR M8		3.80
6.99063	GRAISSEUR M6 90'		3.80

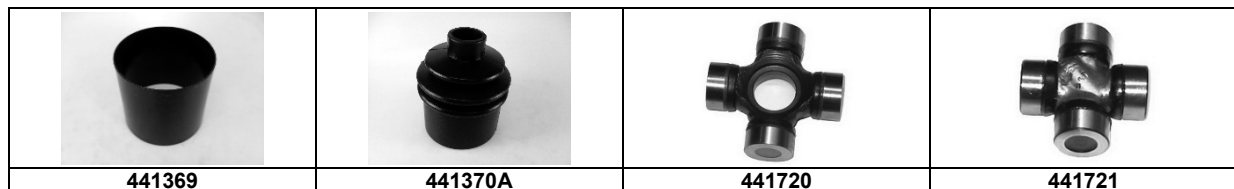
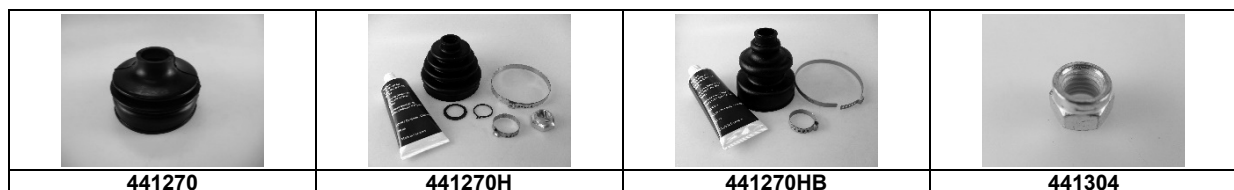
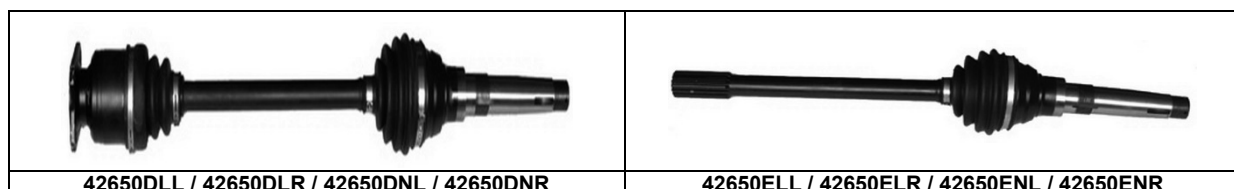
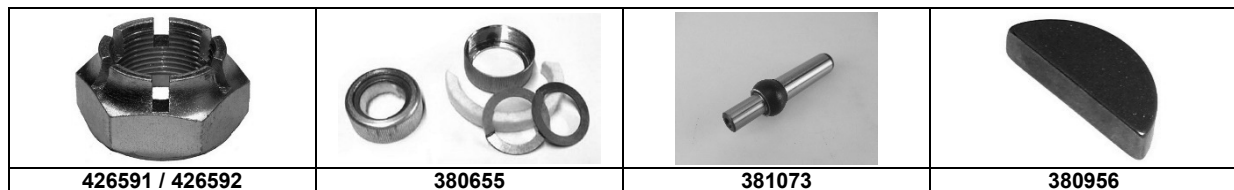

## TRANSMISSIONS ET FUSEES

No d'article	article	Prix CHF
6.99064	GRAISSEUR M6 45°	3.80
6.99065	GRAISSEUR M8 45°	3.80
6.99066	GRAISSEUR M7 90°	3.80
6.99067	GRAISSEUR M6 90°	3.80
6.99068	GRAISSEUR M8 90°	3.80
6.99070	GRAISSEUR M7 45°	3.80
6.99071	GRAISSEUR M7 180°	3.80
6.99072	GRAISSEUR M6 180°	3.80

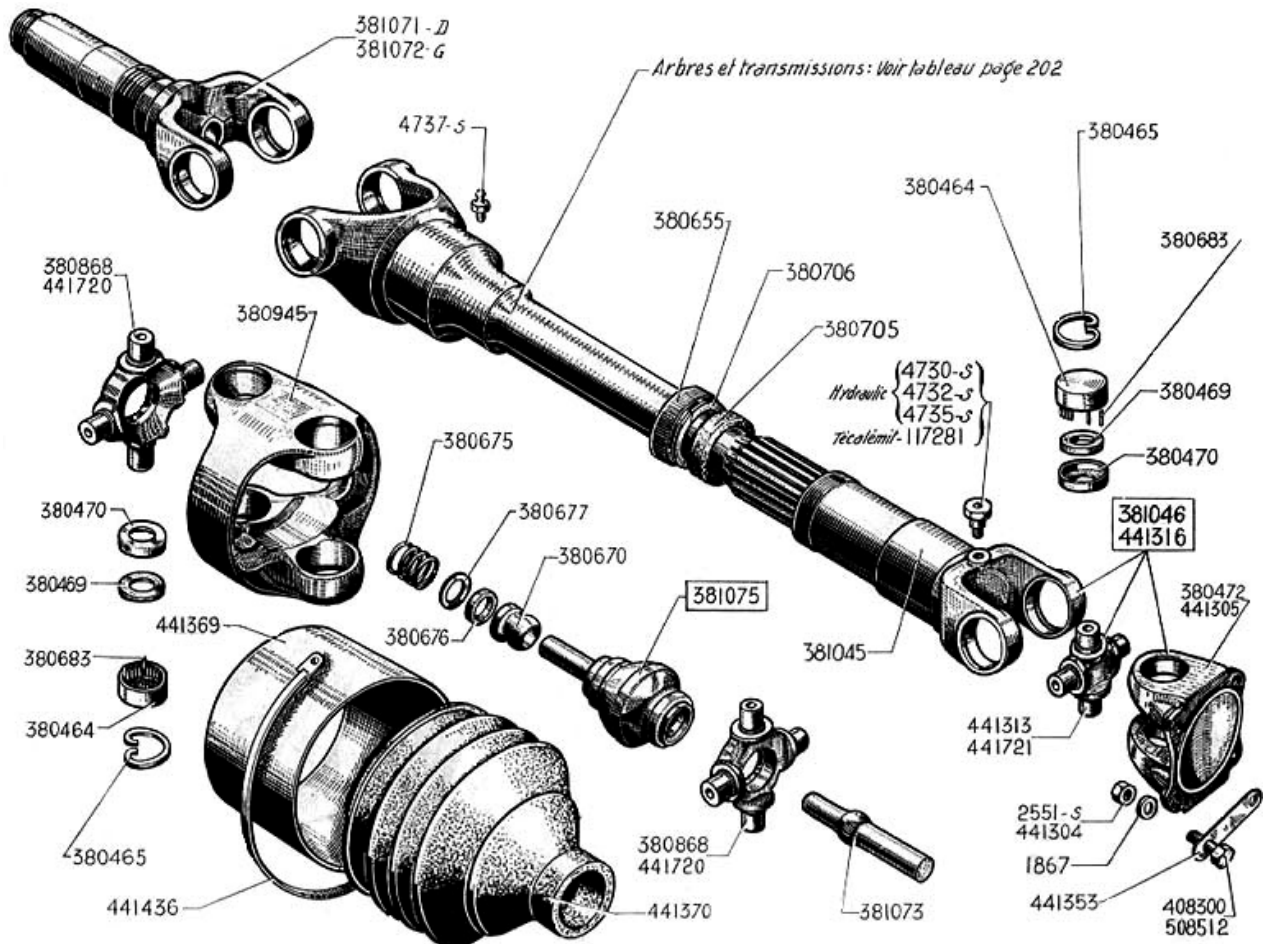

## DIRECTION

No d'article	article		Prix CHF
88066	CUVETTE DE ROULEMENT INF.	49,2mm	38.60
88106	CLAVETTE TRONQUEE DE VOLANT	5x18,5x7,5mm	2.10
88107	CLAVETTE DE LEVIER ACCOUPLE	3x5mm	0.90
89048	RESORT DES NOIX BARRE LA TERALE	O28x8mm	5.90
308398	VIS DE FIXAT DU SUPPORT MOBILE	M8x30	1.50
441319	ROTULE BARRE LAT+COUSSINET	O25x68,5mm	209.80
601535	NOIS ROTULE BARRE LA TERALE	O28x16mm	74.10
601836	NOIX INT.DE ROTULE CREMAILLERE	27,5 mm.	85.60
601843	ECROU BLOCAJE TUBE MAINTIEN	O36,8x23,5mm	33.00
601845	PLAQUETTE OBTURATRICE ROTULES	85x28mm	53.30
601846	ROTULE BARRE LAT+COUSSINET	O25x76mm	57.40
601848	RESSORT RATTRAPAGE JEU DE NOIX	35x21mm	8.00
601849	NOIX EXT DE ROTULE DE CREMAILLERE		18.00
601854	BAGUE CAOUTCH SUPP TUBE FIXE	O47x37x4mm	16.30
601867	COUVRE COUPELLE ROULEMENT SUP.	-	2.70
601869	FEUTRE ETANCHEITE DU CARTER	-	3.60
601871	COUVRE FIXATION TUBE AXE DIR.	-	14.50
601877	ECR REGL ROTULE EXTR BARRE LAT	M34x150	11.50
601879	TUBE COULISSANT ETANCHEITE	380mm	52.00
601924	BOUCHON DE BUTEE DROITE ALU.	M42x150	43.60

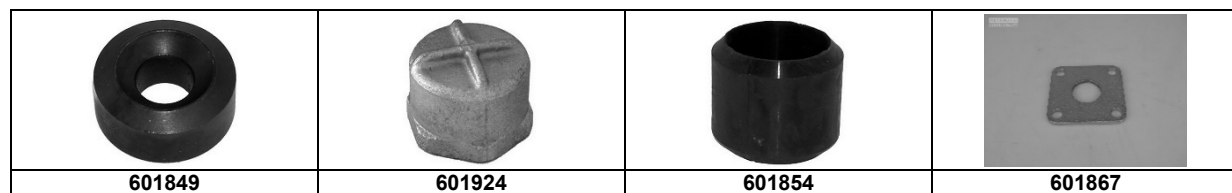
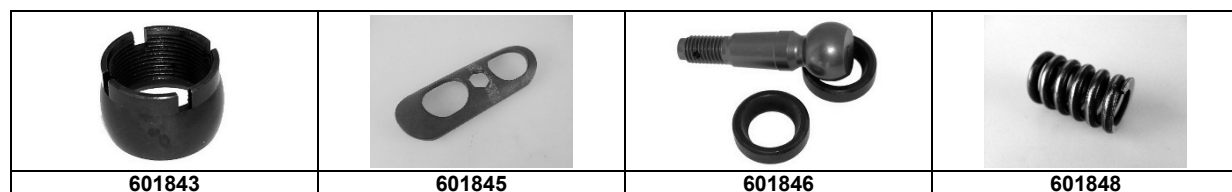
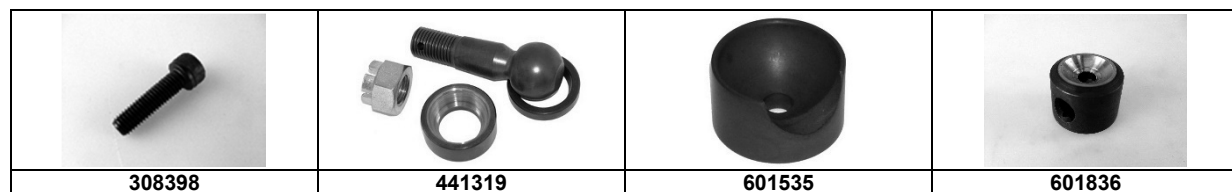
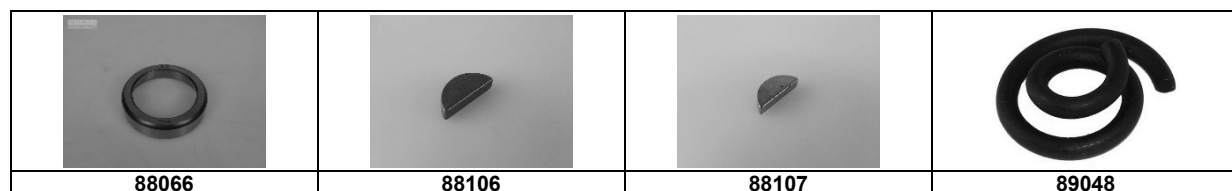

## DIRECTION

No d'article	article		Prix CHF
601946	CA OUTCH ROTULE BARRE DIRECTION	O32x16mm	2.30
601976	TUBE COULISSANT ETANCHEITE	500mm	52.00
601978	PLAQUETTE OBTURATRICE ROTULES	205x28mm	55.80
602008	BOUCHON DE BUTEE GAUCHE	120mm	53.80
602046	CACHE ROTULE EXTR BARRE LAT	O40x12mm	10.30
602052	RONDELLE BARRE DIR 16.5X31X0.5	17x24mm	1.30
602055	ERGOT TUBE ETANCH CREMAILLERE	35x8mm	6.10
602068	JOINT BOUCHON G BUTEE/CARTER		1.20
602098	ARRETOIR BOUCHON DE BUTEE D	-	6.30
602133	BAGUE INT SUPP PLANCHE DE BORD	O47x38x20mm	16.90
602135	ACCORDEON DIRECTION CA OUTCHOUC	O58x132mm	11.90
602135A	ACCORDEON DIR. CUIR DIVISIBLE		48.60
602135AK	COLLIER ACCORDEON DIR. CUIR	O47x1mm	2.40
602169	BAGUE ETANCH TUBE/CARTER	25x23mm	7.60
602322	VIS ORIENTATION DU TUBE CARTER	M10x12	6.40
604099	VOLANT COMPLET 2 BRAS NOIR	O 450mm	166.10
604101	BOUCHON INF. DU VOLANT NOIR	47x34mm	18.90
604102	BOUCHON VOLANT SUP. NOIR	O 95mm	17.70
604116	MOYEU DE VOLANT 9 TROU	O70x32mm	80.60
604126	VIS DE FIXAT. DU VOLANT	M7x29mm	6.10
604145	BOUCHON VOLANT SUP. GRIS	O 95mm	17.20
604146	BOUCHON INF. DU VOLANT GRIS	47x34mm	18.70

			
<b>601946</b>	<b>601978</b>	<b>602004</b>	<b>602008</b>
			
<b>602046</b>	<b>602052</b>	<b>602055</b>	<b>602068</b>
			
<b>602098</b>	<b>602133</b>	<b>602135</b>	<b>602135A</b>
			
<b>602135AK</b>	<b>602169</b>	<b>602322</b>	<b>604099</b>
			
<b>604101</b>	<b>604102</b>	<b>604116</b>	<b>604126</b>

## DIRECTION

No d'article	article		Prix CHF
604147	VOLANT COMPLET 2 BRAS GRIS	O 450mm	164.20
2551-SS	ECROU FIXAT DU BOUCHON.	M8x125	0.50
2613-SS	ECROU LIMITEUR DIRECTION	M10x150	1.90
601847K	BOITE DE ROTULE + 2 CUP	O25x84mm	63.50
601938/9	FERBLANTIER PROT.CARTER AR + AR BL		61.60
601980/1	FERBLANTIER PROT.CARTER AR + AR B	-	73.60
602053S	CALE DE REGLAGE TOLE FERMETURE		7.50
602054A	CALE REGLAGE TOLE DE FERM.1.00	62x60x1mm	7.20
602350W	PIGNON DE DIRECTION	38x101,5	135.20
602350WP	CLIQUET ARRET PIGNON DIRECTION	5x40mm	4.90
604129/30	CAOUTCH FIXE VOLANT TUBE HAUT	O36,7x22,5x30mm	18.90
88066-7S	JEU DE BUTEE DE PIGNON	49,2x11,1;50,4x16,7	115.90

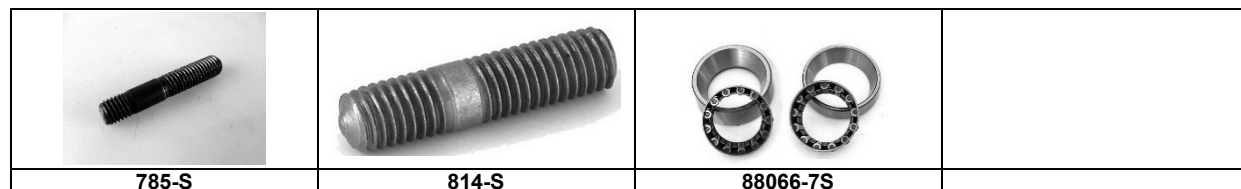
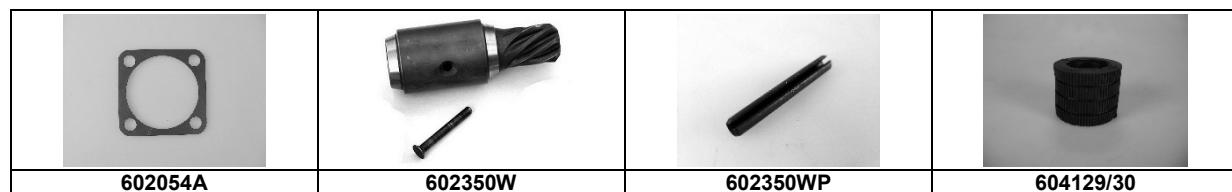
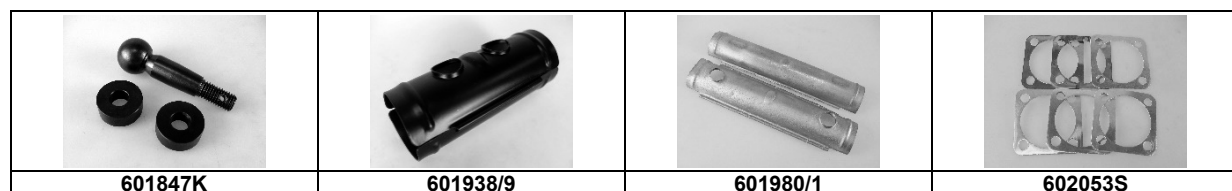



## TAMBOURS AV ET ROULEMENTS

No d'article	article		Prix CHF
2717-S	GOUPILLE FENDUE ECR BLOC MOYEU		0.30
380956	CLAVETTE MOYEU-TAMBOUR	6mm	4.30
392581	ECROU ROUE PILOTE 18 MM LONG	M12x125	10.10
392581A	ECROU FIXAT DE ROUE BELGE	M12x125	14.00
425655	ARRETOIR ECROU ROULEM INT FUSEE	35,5mm	5.10
425656	ECR SERR ROULEM INT. FUSEE G	35x150	13.40
425661	ARRETOIR ECROU ROULEMENT EXT.	5,5mm	3.40
425948	JOINT DE PIVOT DE FUSEE EXT	53x68x10mm	7.40
425964	ECROU ENCOCHES ROULEMENTS	78x150	15.90
426020	JOINT DE PIVOT DE FUSEE INT	45x65x8mm	8.40
426493	ECR SERR ROULEM INT. FUSEE D	35x150	14.90
426591	ECROU BLOCAJE MOYEU AV FUSEE G	26x150	14.90
426592	ECROU BLOCAJE MOYEU AV FUSEE D	26x150	20.30
426731	TOC DE ROUE 29MM	M12x125x29mm	12.90
431175	TOC DE ROUE 38.5MM	M12x125x38,5mm	16.10
441315	MOYEU-TAMBOUR AV 12	O12"/345mm	682.00
441510	ROULEMENT EXTERIEUR AV FUSEE	O72x32x19mm	55.40
441511	ENTR ROULEM INT/EXT FUSEE 34MM	34mm	32.30
88091	ROULEM INT GORGE PROF FUSEE	35x72x17mm	24.30
A416-2	TOC DE ROUE 31.5 MM	M12x125x31mm	12.70
6.90841	ECROU DE ROUE	M12x125	5.00

			
380956	392581	392581A	425655
			
425656	425661	425948	425964
			
426020	426493	426591 / 426592	426731
			
6.90841	431175 / A 416-2	441315	441510
			
441511	88091		

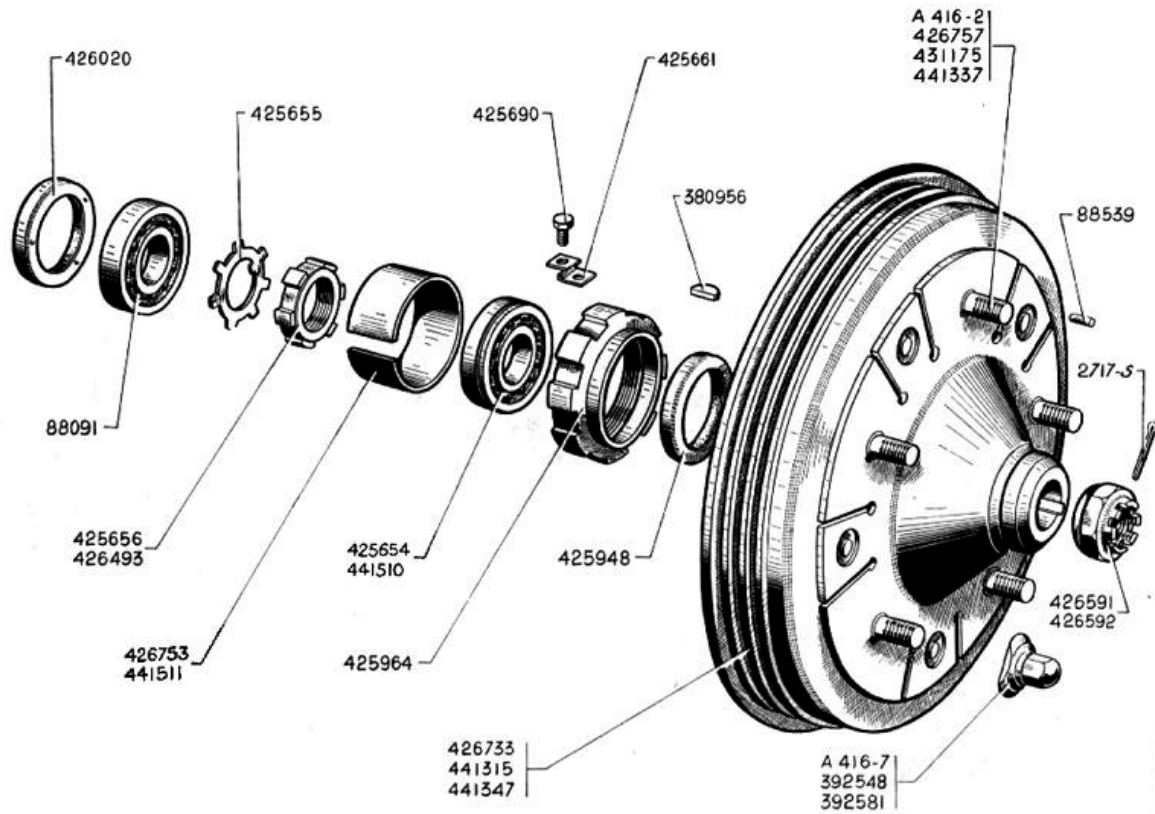

### FREINAGE

No d'article	article	dimension	Prix CHF
2080	ROND COLONN GUIDAGE SEGM FREIN	6.5x16x1.5mm	0.60
6.99010	ECROU M7X100	M7x100	0.20
302-S	VIS CYLINDRE SUR PLATEAU	M6x10	0.40
373004	COUPELLE DE FREIN AV 1 1/4	O 1 1/4"	5.10
373002S	CACHE-POUSSIERE CYL. FREIN 1"	O 1"	6.40
373005	COUPELLE DE FREIN AR 1	O 1"	3.90
373005S	CACHE-POUSSIERE CYL. FREIN AV	O 1 1/4"	7.70
415766	BIELLE DE FREIN S MAIN	105x18mm	9.80







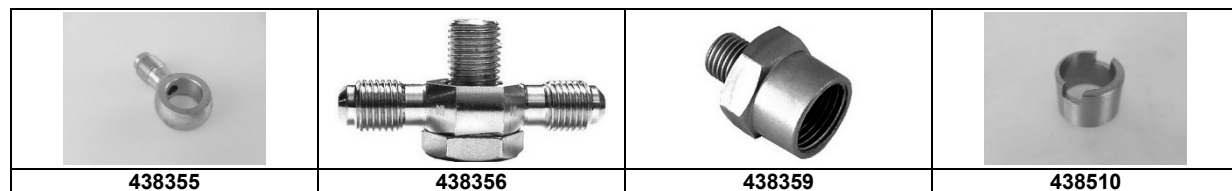
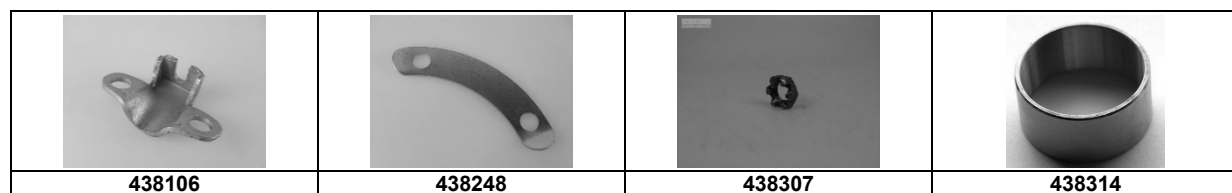
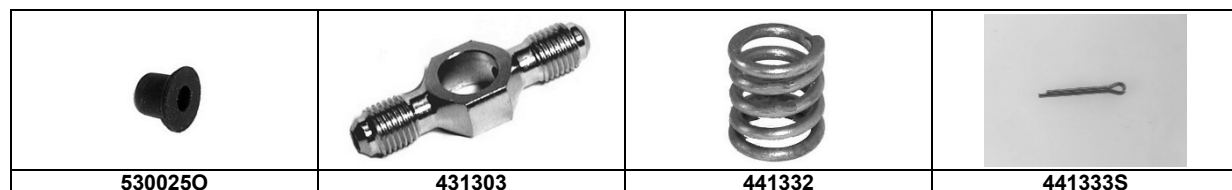
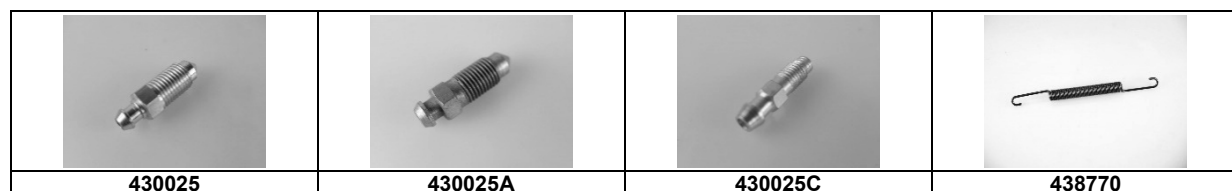













## FREINAGE

No d'article	article	dimension	Prix CHF
430025	VIS DE PURGE AV	11mm	9.80
430025A	VIS DE PURGE AR	9,5mm	6.20
430025C	VIS DE PURGE AV/AR 8MM	M8x1	4.90
430025O	CAPUCHUN VIS DE PURGE	-	1.50
431303	RACCORD 2 VOIES CYLINDRE ROUE	10x56,3mm	22.00
438248	ARRET DOUBLE ECROU VIS PLATEAU	51mm	8.00
438307	ECROU AXE ARTICULATION SEGM	14x150	4.40
438314	BAGUEE BRONZE DE SEGMENT	20x22x10	8.10
438355	RACCORD ORIENTABLE CYL ROUE	10x38,8mm	18.90
438356	VIS RACC ORIENTABLE CYLINDRE	11,11x23mm	19.60
438359	RACC ACIER DE CONN CYL ROUE AV	22x32mm	11.40
438510	BAGUE DE REGLAGE DE SEGMENT	16x20x13mm	18.00
438511	PLAQUETTE ENTRETOISE		2.00
438586S	GOUPILLE PLAQ.FREIN VIS CENTR	3,2x32	0.40
438608	RONDELLE REGL AXE ART FREIN	14.5x20x1mm	1.80
438621	RONDELLE CENTR PLAQ. DE FREIN	17x28x2,5mm	0.70
438770	RESSORT RAPPEL SEGMENTS AV/ARR	136x10mm	7.20
441332	RESSORT COLONNETTE APPUI SEGM	10,5x13mm	2.30
441333S	GOUPILLE PLAQ.FREIN VIS MONT	2x16mm	0.40
520601	FLEXIBLE AR	155mm	27.00
520602	FLEXIBLE AR	215mm	25.70

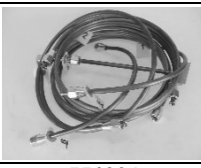

## FREINAGE

No d'article	article	dimension	Prix CHF
520608	FLEXIBLE AV	415mm	33.80
520609	FLEXIBLE AV	510mm	37.10
550878B	RESERV.FLUIDE DES FREINS NOIR	101x65mm	196.40
550878G	RESERVOIR FLUIDE FREINS VERRE	O72x140mm	45.90
550878S	ETIQUETTE RESERV FLUIDE FREINS	90x80mm	7.10
550881R	RACC CAOUTCH BIDON RES FLUIDE	28x50mm	7.60
550887	BOUCHON DE RESERVOIR HUILE	O53x18mm	3.50
550900	JOINT RACCORD SYSTEM DE FREIN	9 stk/pc	9.50
550908	RACCORD ARR AU MAITRE-CYLINDRE	19,5x16	14.60
550910	VIS DU RACCORD	12,7x30	13.00
550911	RACCORD SORTIE MAITRE-CYL 3V	-	42.00
550917B	ROND RESSORT NIPPLE FLEX FREIN	M11	1.10
550919	ECROU POUCE RACCORD CONNEXION	11,11x20	2.80
551001	JEU TUBE DE FREIN	6 stk/pc	128.50
5510012	FIXATION DE TUBE DE FREIN	O6,5mm	0.90
551002	JEU TUBE DE FREIN	6 stk/pc	128.50
551003	JEU TUBE DE FREIN	7 stk/pc	128.50
551004	JEU TUBE DE FREIN	7 stk/pc	128.50
6.20715	TUBE DE FREIN MATERIEL CUNIFER	6,00x4mm	20.40
6.20720	TUBE DE FREIN MATERIEL CUNIFER	6,35x4mm	20.20
551011	ECROU TUBE DE FREIN 11X19	14x19,2mm	3.70
551020	TUBE DE FREIN PROT. RESORT	O9x7mm	18.70
551055	NIPPLE TUYAU FREIN MAITRE-CYL.	29x16x8	7.30

			
520608 / 520609	550878B	550878G	550878S
			
550881R	550887	551011	550900
			
550910	550911	550919	551001
			
5510012	551002	551003	551004
			
6.20715 6.20720		551020	551055

## FREINAGE

No d'article	article	dimension	Prix CHF
551511	TUYAU MAITRE-CYLINDRE	0,405m	31.40
551922	RACCORD DU TUBE FLEX AR	17,5x16x60mm	9.40
552009	NEC.REP MAITRE-CYLINDRE	O25.4mm 1"	33.80
552009C	COUPELLE PRIM MAITRE-CYLINDRE	25-4x6.5mm	7.60
552044	RACCORD AR 3 VOIES	10x100	126.80
553200	RACC SORTIE DU MAITRE-CYLINDRE	10x100	18.20
553201	TUYAU MAITRE CYLINDRE	0,345m	31.40
553201B	TUBE FREIN MAITRE CYLINDRE	0,345m	38.10
553204	RACCORD 4 VOIES	10x100	172.50
553265	TUBE DE FREIN	2,75m	51.00
621004	CYLINDRE DE FREIN AR 1	1"	98.80
621299	CYLINDRE DE FREIN 1 1/4	1 1/4"	96.50
624140	MAITRE-CYLINDRE	O 1", hoh 60mm	103.50
624142S	PARE-POUSSIERE MAITRE-CYLINDRE	36x54mm	2.60
89143	VIS DE FIXAT DE PLATEAU	M7x15mm	1.60
165002	PATE FREINE	-	22.40
6.91404	LIQUIDE FREIN DOT 4	1000ml	14.00
552044	TUBE FREIN MAITRE CYLINDRE 4.52 -		126.80
553201B	RACCORD AR 3 VOIES		38.10
551511B	TUYAU MAITRE-CYLINDRE		35.60

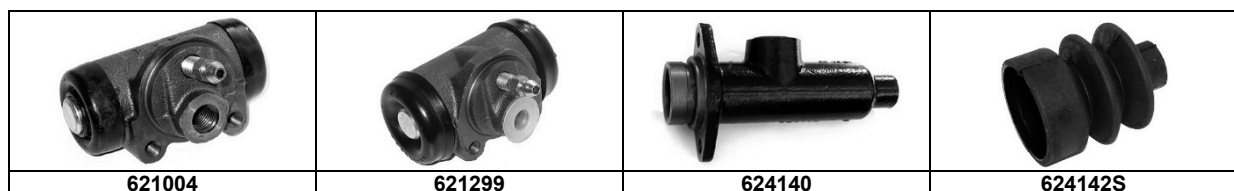
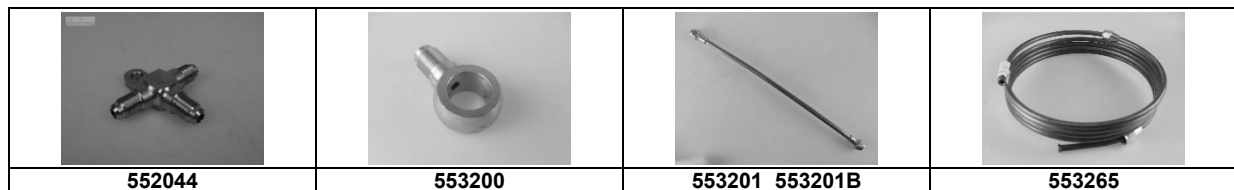
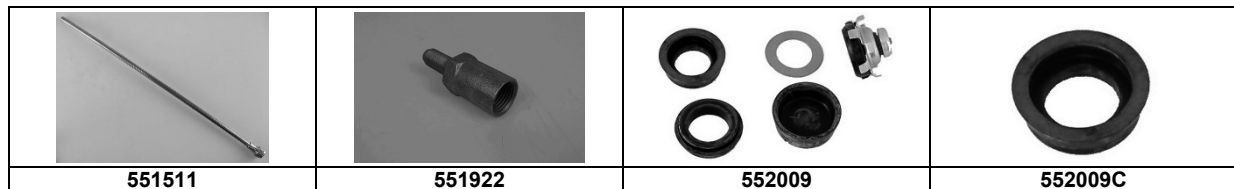

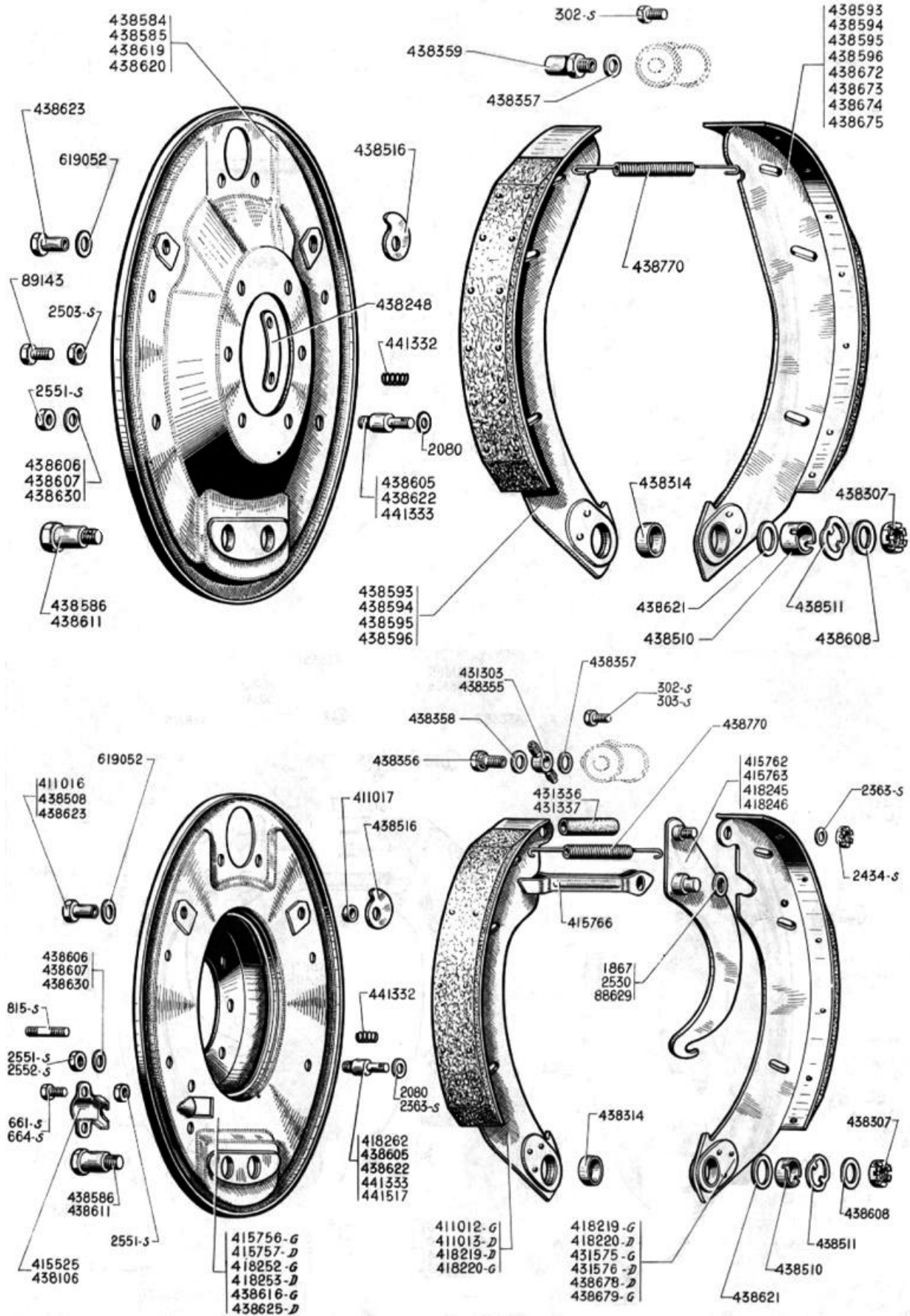

## TAMBOURS AR ET ROUEMENTS

No d'article	article		Prix CHF
2165-S	JOINT SPI DE FUSEE ESSIEU AR	45x62x10mm	7.30
2185-S	JOINT SPI DE FUSEE ESSIEU AR	50x72x10mm	7.50
420962	ROULEMENT ROUE ARRIERE	30x62x16mm	25.70
421024	ECROU BLOCAJE TAMBOUR	20x150	12.20
6.17012	ROULEMENT DIFF. 2CV		33.10

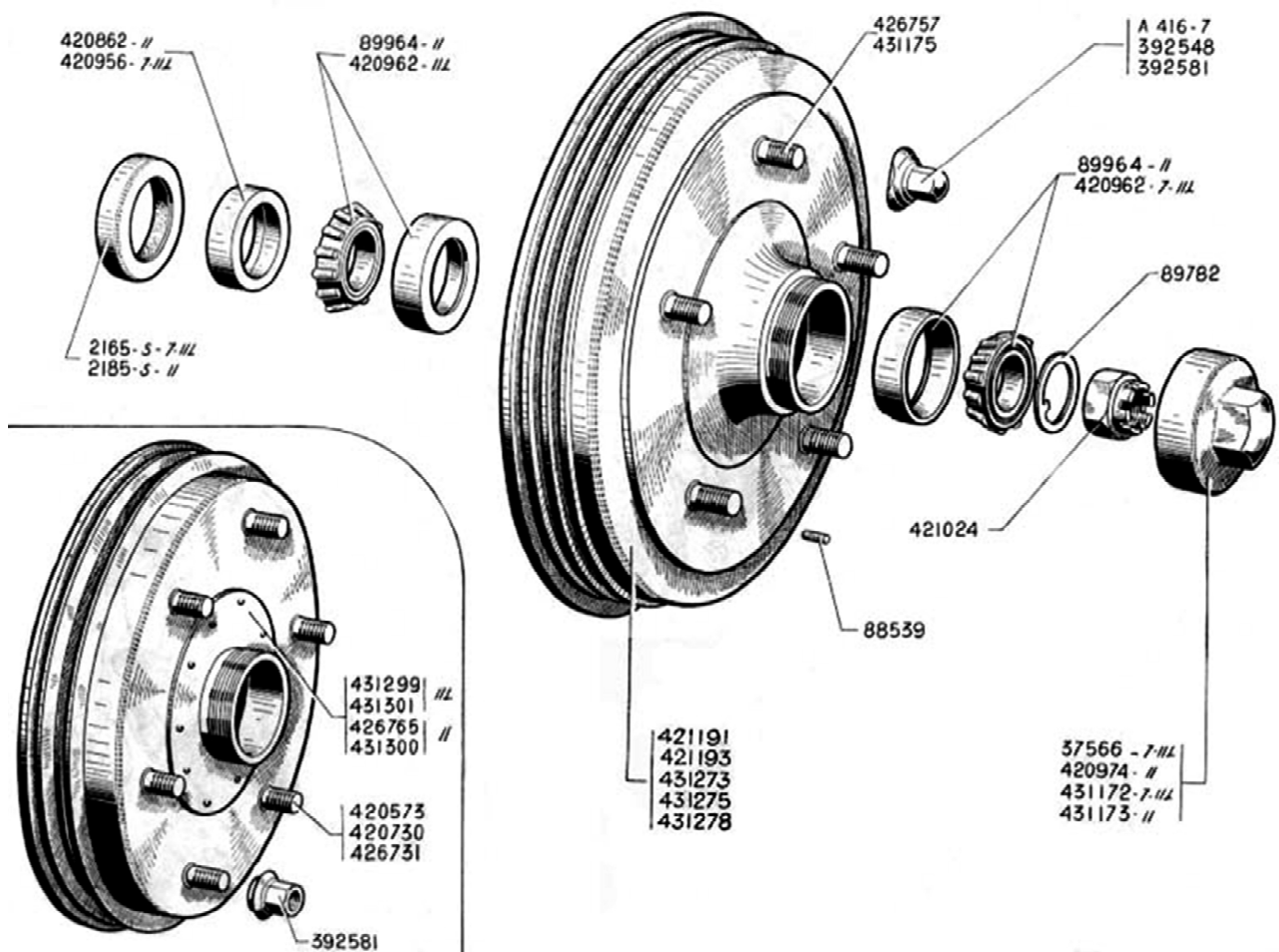
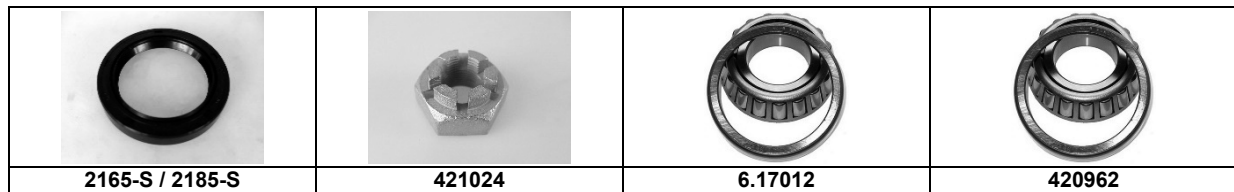

## FREIN A MAIN

No d'article	article		Prix CHF
118300	AXE CHAPE DE CABLE DE TIRETTE	8x24mm	3.80
1867	ROND. AXE INF. LEV. FR. A MAIN	8.5x15x2mm	0.90
2363-S	RONDELLE MONT LEV FREIN A MAIN	6x14x1.5mm	0.60
2434-S	ECROU H AXE SUP LEVIER COMM	M6x100	1.80
305764	AXE ATTACHE GAINE	M7x38,5	8.00
552085A	OBT CA OUTCH POIGNEE FR A MAIN	O14x82mm	4.40
552115	CABLE FREIN A MAIN G/D 11BL	2540x845mm	54.70
552116	CABLE FREIN A MAIN G/D 11BN	2750x875mm	54.70
552143	CABLE FREIN A MAIN G/D 15FAM	2970mm	91.80
553170	RESSORT POIGEE DE FREIN A MAIN	72mm	13.60
553237	POIGNEE DE FREIN A MAIN CHROME	-	144.70
588320	RESSORT DE LEVIER DE FREIN	15x138mm	8.80
88199	ECROU DOUILLE TEND CABLE FREIN	M8x21,5mm	8.00
88629	ROND AXE INF. LEV FREIN A MAIN		0.80
550810	CA OUTCHOUC ARBRE POIGEE		8.10

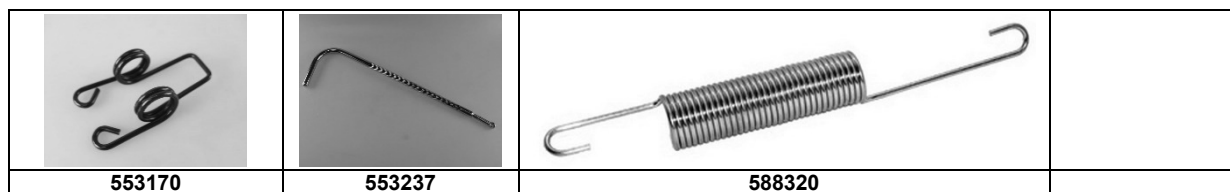
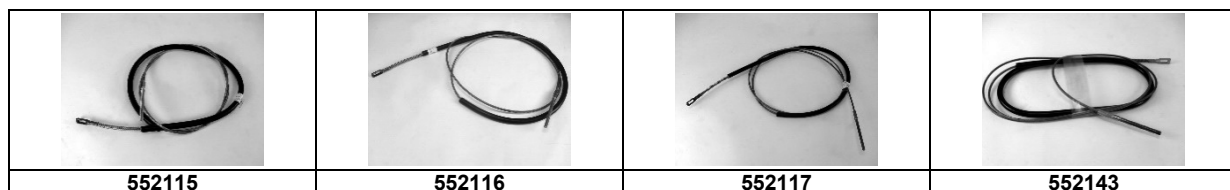

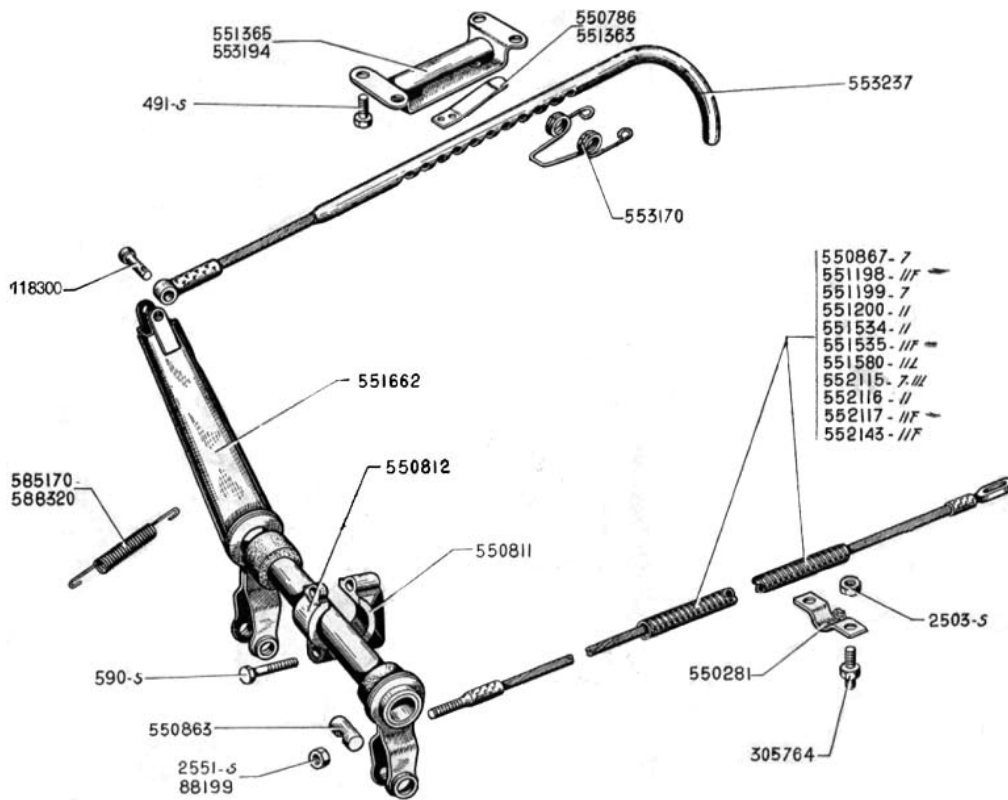

### PEDALIER

No d'article	article		Prix CHF
540545	BARILLET DE CABLE DE DEBRAYAGE	14x25mm	4.80
540565	ECROU A BOUILLE CABLE BARILLET	M7x15,5mm	10.10
540964	RESSORT RAPPEL DE PEDALE G	34x40mm	13.10
540965	RESSORT DE RAPPEL DE PEDALE	34x40mm	29.20
540966	ENTRET SUPPORT MAITRE CYLINDRE	8x32	4.30
540975	FREIN-VIS AXE PEDALES	O18,5	4.00
540983	GARNITURE CAOUTCH DES PEDALES	82,5x61x13mm	14.90
540988	AXE CABLE DEBRAYAGE SUR PEDALE	8x25,5mm	3.30
540992	CABLE DEBRAYAGE - 45	-	100.90
453420	CABLE DE DEBRAYAGE		51.90
543265	SUPPORT CABLE DEBRAYAGE	13,5mm	10.40
543326	BAGUE DE PEDALE DE FREIN	18x22x28mm	13.50

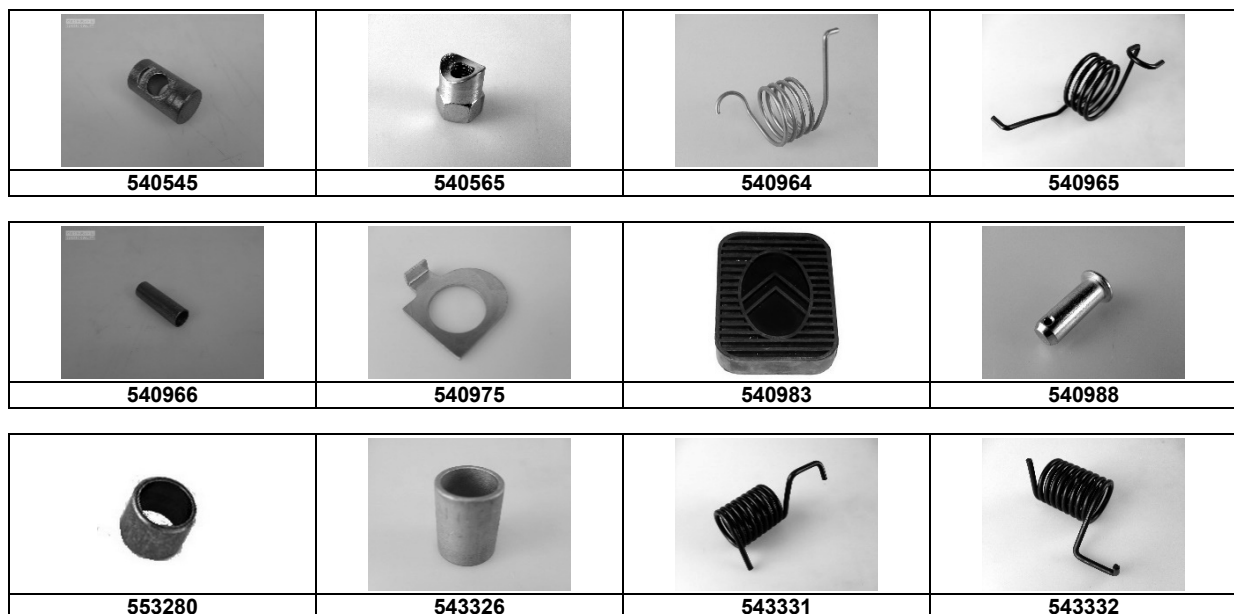

## PEDALIER

No d'article	article		Prix CHF
543331	RESSORT DE RAPPEL DE PEDALE	21x66mm	8.30
543332	RESSORT DE RAPPEL DE PEDALE G	21x66mm	15.50
543341	ECROU DOUILLE REGL CABLE DEBR	m7	9.40
543348	CABLE DEBRAYAGE	665mm	63.70
543358	SUPPORT CABLE DEBRAYAGE	104x40mm	11.90
543360	PATTE ACCR RESSORT DEBRAYAGE	29x20mm	12.30
543392	AXE CHAPE DU CABLE DEBRAYAGE	8x22mm	3.80
543419	CABLE DE COMM. DEBRAYAGE	705mm	43.90
543420	CABLE DE COMM. DEBRAYAGE	740mm	50.40
553280	ENTRE SUPP MAITRE CYL/CLOISON	8x10x8,5	1.60
590-S	VIS MAITRE CYLINDRE	M7x65	1.60
592-S	VIS SUPPORT MAITRE CYLINDRE	M7x75	1.00
89020	RESSORT FOURCH. EMBRAYAGE	17,5x94	8.00
540964-5	KIT RESSORTS DE PEDALE FREIN EMBRY AGE		17.60

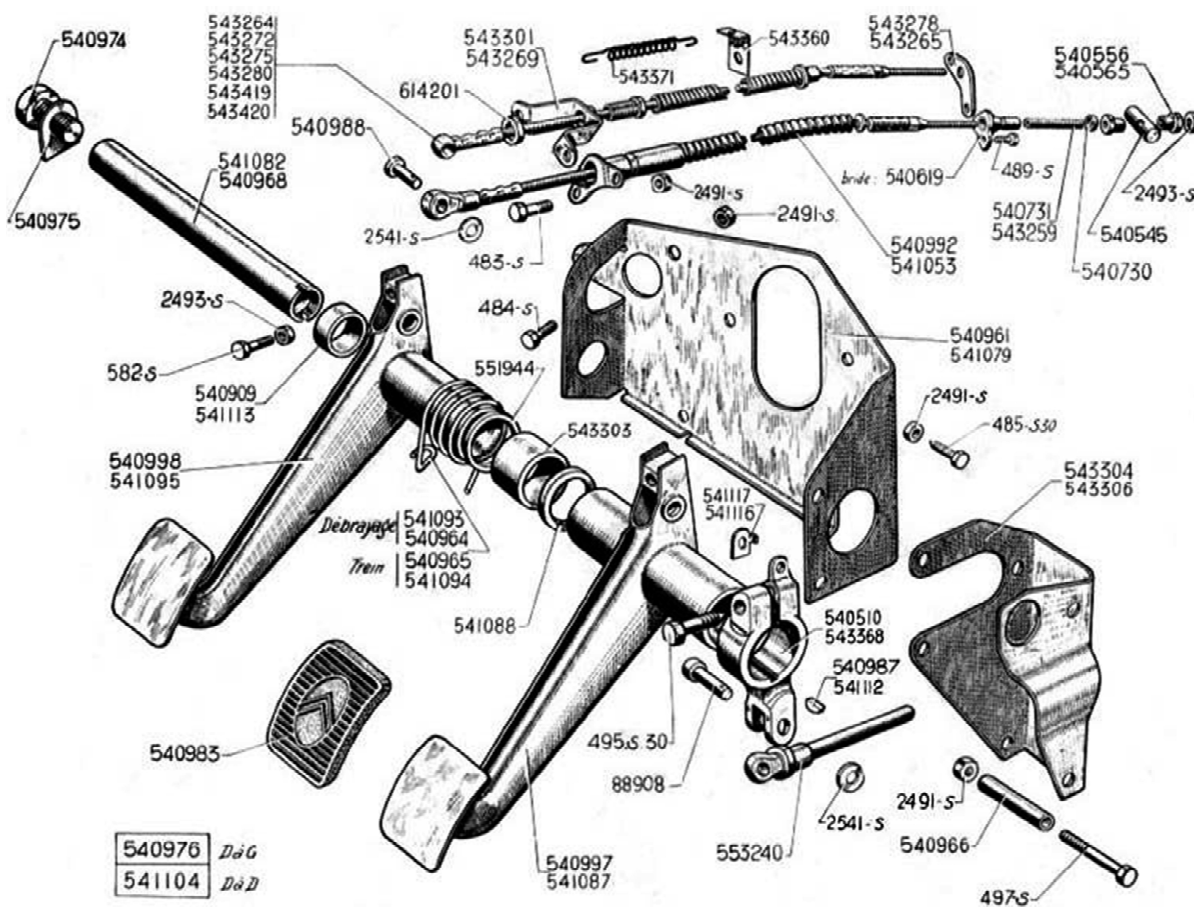
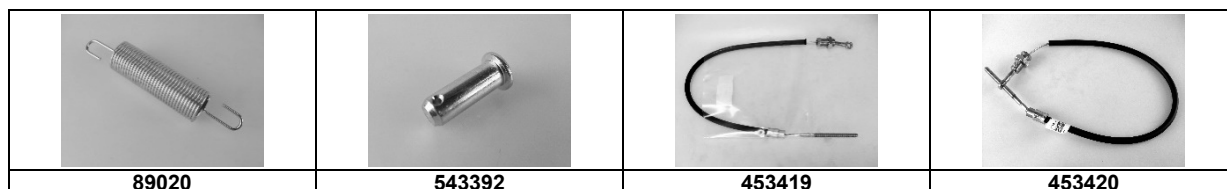
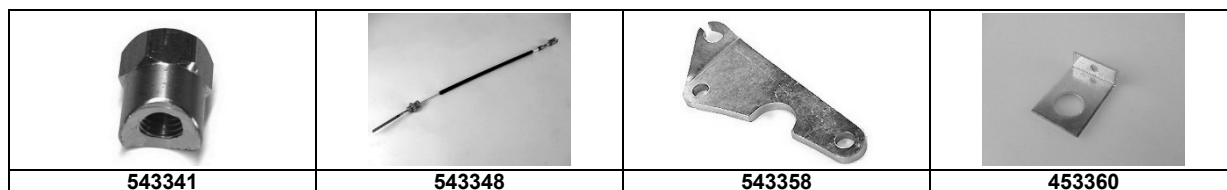

## DEMARREUR

No d'article	article		Prix CHF
2573-S	RONDELLE VIS CONTACT DEMARREUR	8,5x14	0.60
461258	COURONNE DE DEMARREUR	O265mm 93t	153.40
701164/5	JEU BALAIS DEMARREUR CITROEN	17x9mm	58.40
701227	ARRETOIR SIMP VIS DOUILLE ENTR	10x18mm	5.30
701275	COUSSINET PALIER FIXAT CITR AV	14,2x17,2x18mm	10.90
701325	VIS FIXATION DEMARREUR	M12x42	4.30
701452	COUSS PALIER COTE COLL CITR AR	15x18x22mm	13.10
701714S	CALE DEMAR COUVRE BAL CITR 0.3	16x22x0,3mm	0.80
701714SA	CALE DEMAR COUVRE BAL CITR 0.5	16x22x0,5mm	0.80
701714SB	CALE DEMAR COUVRE BAL CITR 0.3	16x22x1mm	0.80
701715SA	CALE TETE DEMARREUR CITROEN	14x26x0.5mm	1.90
701763A	VIS CONTACT DEMARR. RELAIS EXT	M8x40 messing	2.40
701805	RESSORT ENTRAINEMENT BENADA	O46x38x5mm	17.30
701828	RESSORT DU PIGNON BENDIX	24x32,5mm	10.20
701837	PALIER COTE COLLECTEUR DUC	O110x28mm	41.80
701837S	CALE DEMAR COUVRE BALAIS DUC	16x22x0,3mm	0.80
701841	JEU BALAIS DEMARREUR DUCCELLIER	19x8,8mm	51.70
701845	BAGUE PALIER COTE COLL. DUC	16,2x19x15mm	4.50
701849	RONDELLE AXE COLL. DEMARREUR	16,5x26x1mm	1.50
701854	BAGUE PALIERS P.RH. AV/AR/C	16x19x15mm	5.20
701863	JEU BALEIS DEMARREUR P.RH.	18x7mm	52.80
701868S	CALE DEMAR COUVRE INT P.RH 0.3	16x28x0,3mm	0.80

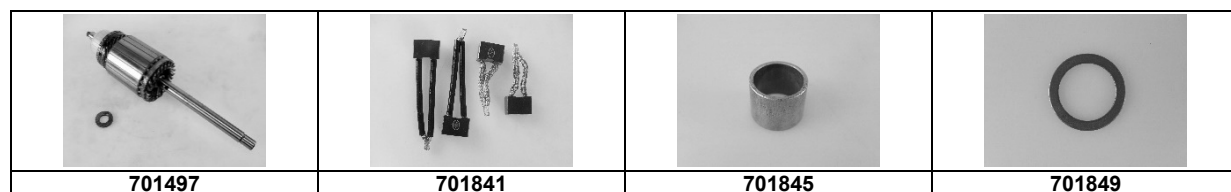
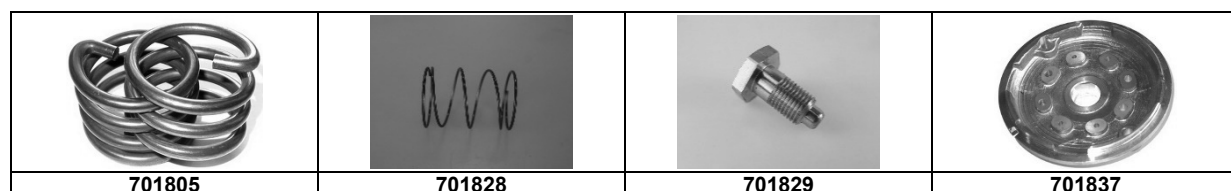
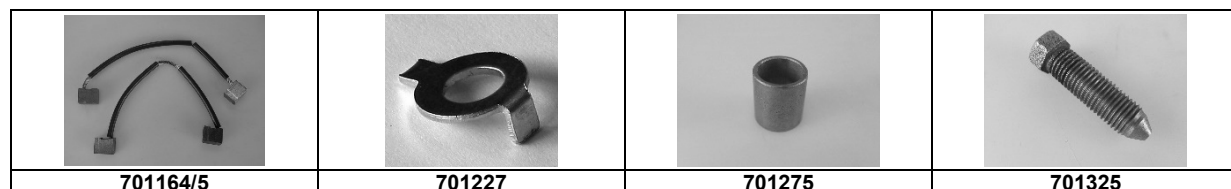
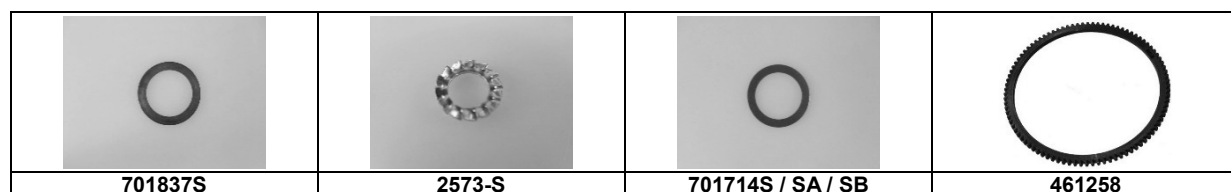

## DEMARREUR

No d'article	article		Prix CHF
701868SA	CALE DEMAR COUVRE INT P.RH 0.5	16x28x0,5mm	1.90
701868SB	CALE DEMAR COUVRE INT P.RH 1.0	16x22x1mm	0.80
712097	CAME NUE	4mm	17.40
712404	ISOLANT DE BORNE INTERRUPTEUR	27x16mm	7.60
712410R	NEC REP CONTACT DEMARR CITROEN	6 PC	51.30
88294	ECROU FIXATION DEMARREUR	M12x150	2.00
89019	RESSORT DE MAINTIEN DE CAME	-	11.30
89820	RONDELLE VIS CONT. DEMARREUR	8x17x1,5	0.40
D533-21B	LANCEUR COMPLET BENDIX		162.00
DS533-28	DOUILLE ENTRAINEMENT BENDIX	-	17.70
70001C	CLIP INTERIEUR CABLE DE DEMARRAGE		4.20
701355	RESSORT ENTR LANCEUR BENDIX		14.40
701846	BAGUE PAL. COTE ENTR./INT. DUC		4.70
716945	BOUTON ROND CABLE DEMARREUR		33.80

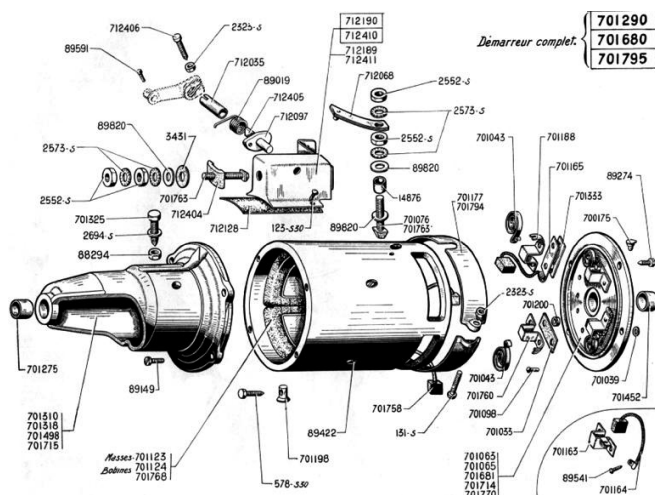
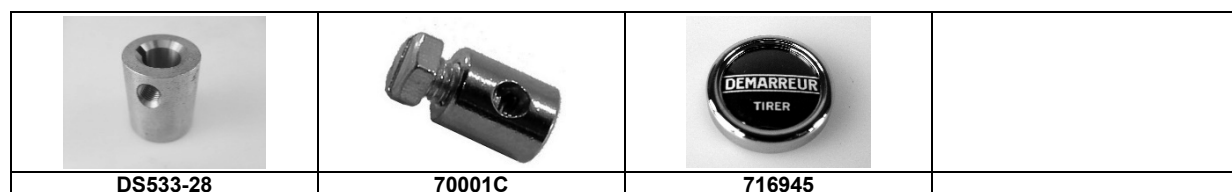
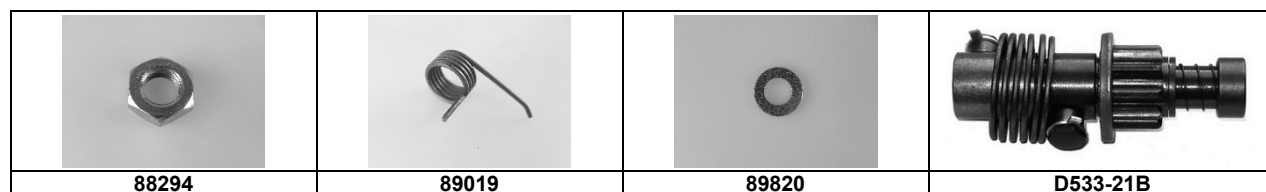
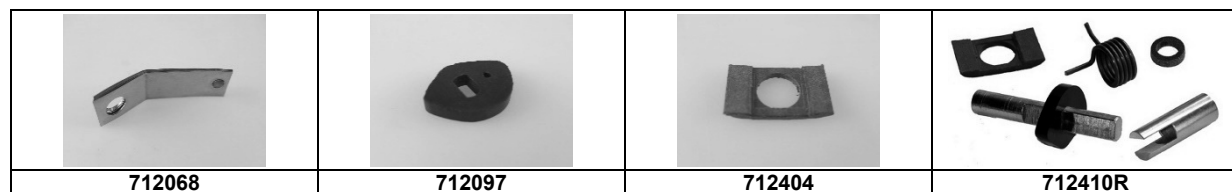
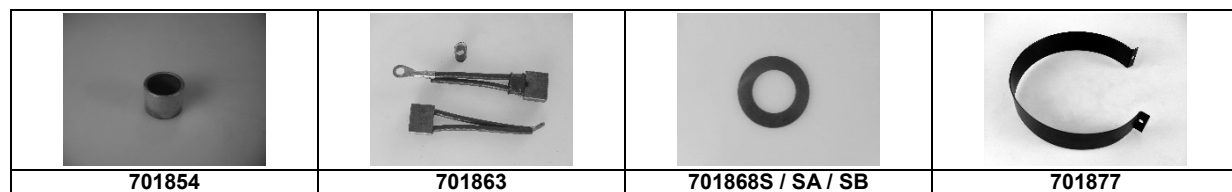

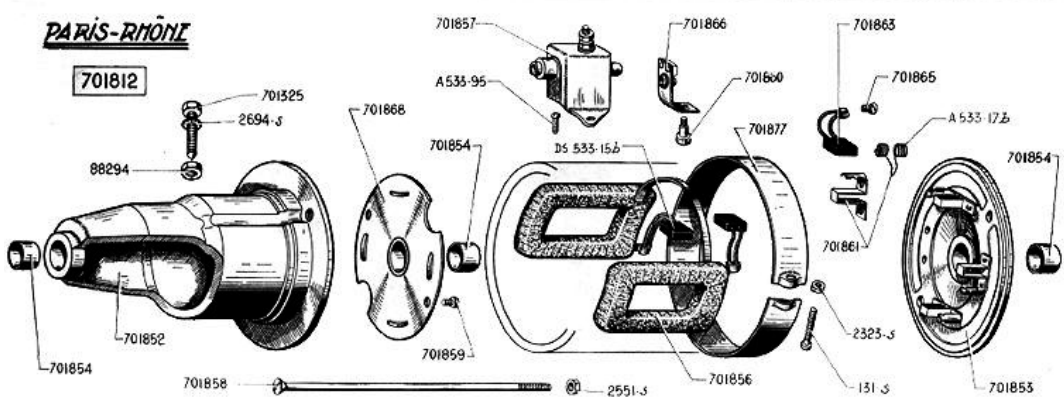
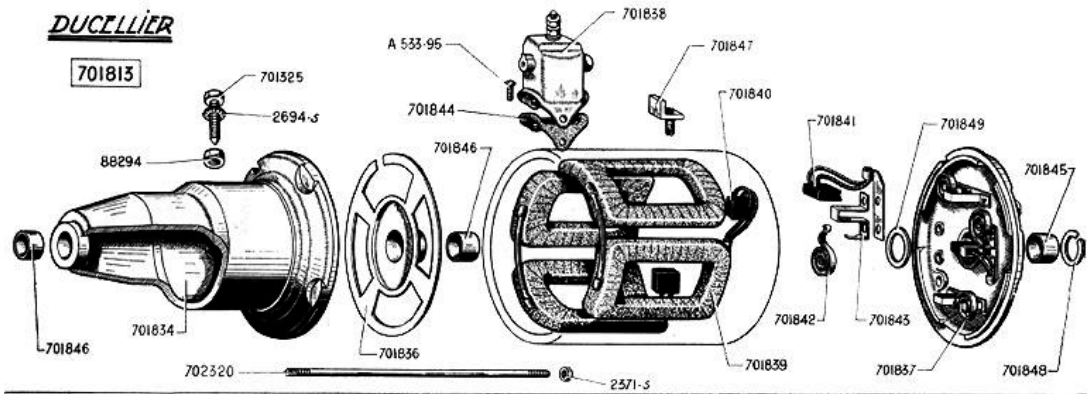
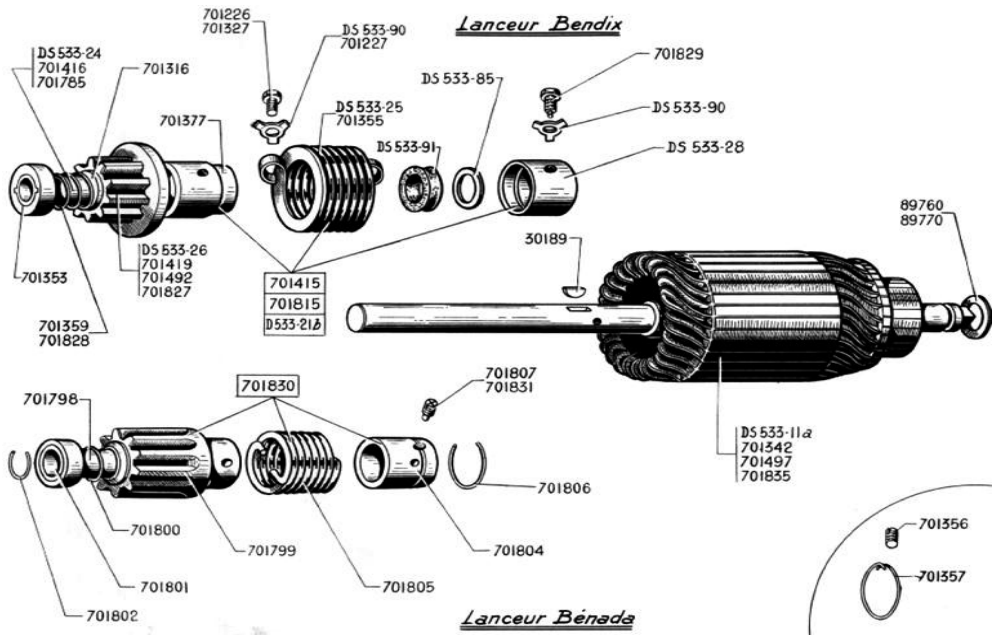

## DYNAMO

No d'article	article		Prix CHF
2694-S	RONDELLE CRANTEE ECROU POULIE	13x20x1	0.60
3291-S	BAGUE PALIER COTE COLL CITROEN	16x20x22mm	9.30
700338	JEU BALAIS ALTERNATEUR CITROEN	19x6mm	12.40
700407	POULIE VENTILATION ALTERNATEUR	80mm	54.00
700554	REGULATEUR TENSION 6V 25A MEC	-	282.20
700884	POULIE VENTILATION ALTERNATEUR	78x41x28mm	58.60
702252	ROULEMENT ALTERNATEUR P.RH.	17x47x14	21.60
702280/93L	BAGUE COTE COLLECTEUR P.RH/DUC	17x21,15x20mm	17.60
702281	JEU BALAIS ALTERNATEUR DUC	19,5x7,2mm	29.80
702294	BALAI DYNAMO PARIS-RHONE	18,5x7mm	29.80
702310	ALTERNATEUR 7.4V/35AMP.	70Amp	435.40
702310H	COURANT ALTERNATIF DYNAMO SUPP	140x80mm	49.40
702310R	REGULATEUR TENSION ELECTR 7V	6V elekt	194.40
702310S	REGULATEUR TENSION ELECTR 12V	12V elek	40.10
702311	ALTERNATEUR 12V/75AMP	75Amp	472.50
705654	PLAQ DIODES ALTERNATEUR 702310	-	88.80
30189	CLAV POMPE EAU/ALT/ARBRE COMM.		1.50
700914	TENDEUR DE COURROIE		19.40
700915	POULIE DYNAMO		94.00

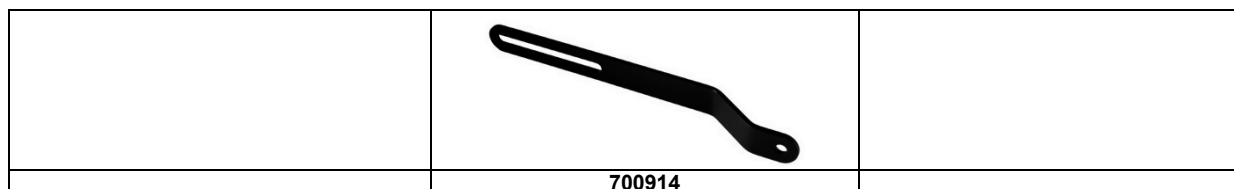
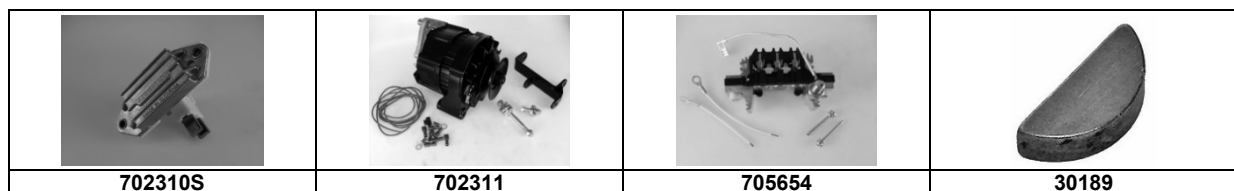
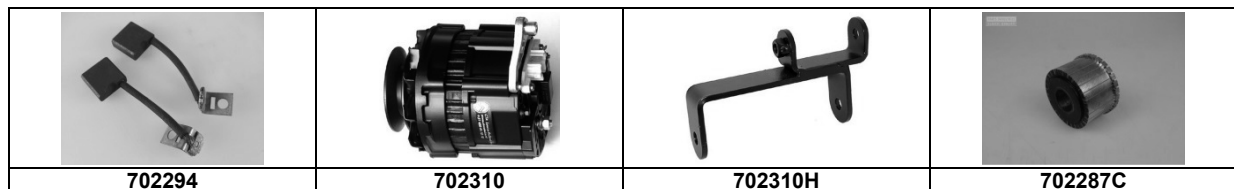
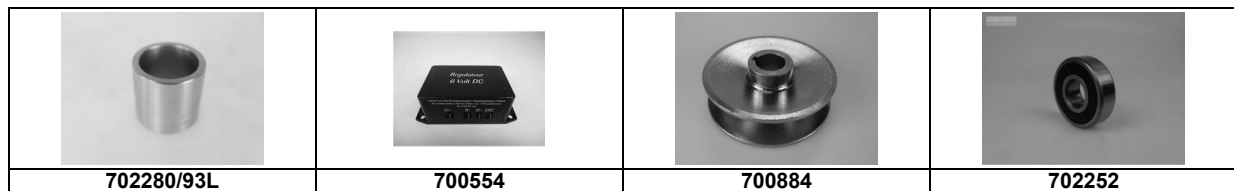

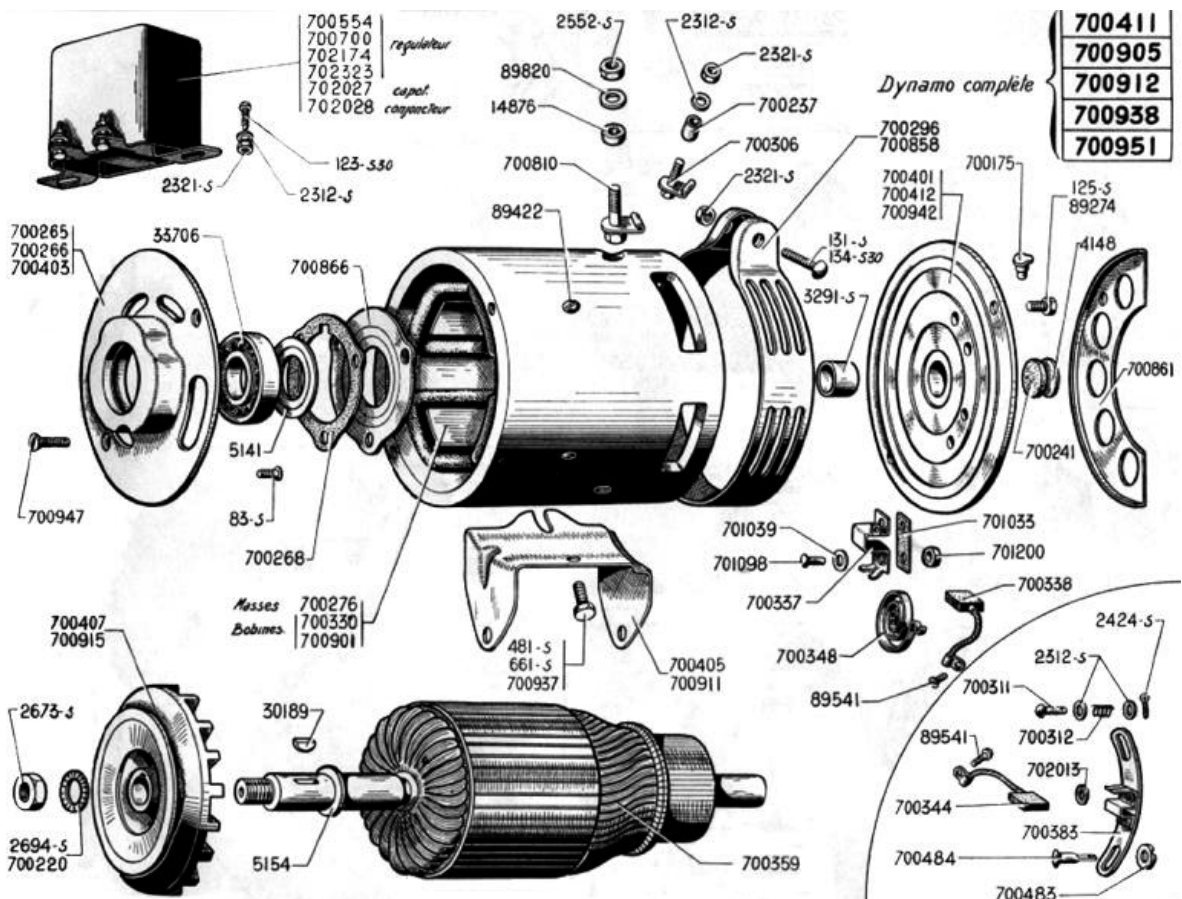
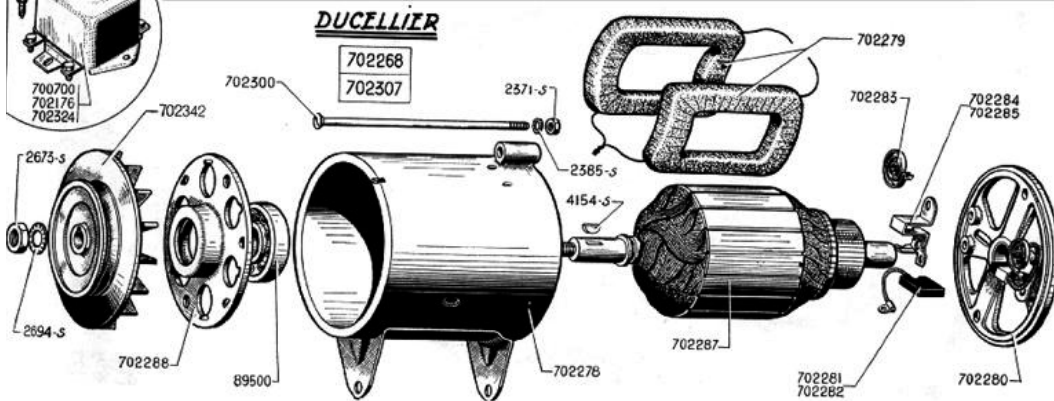
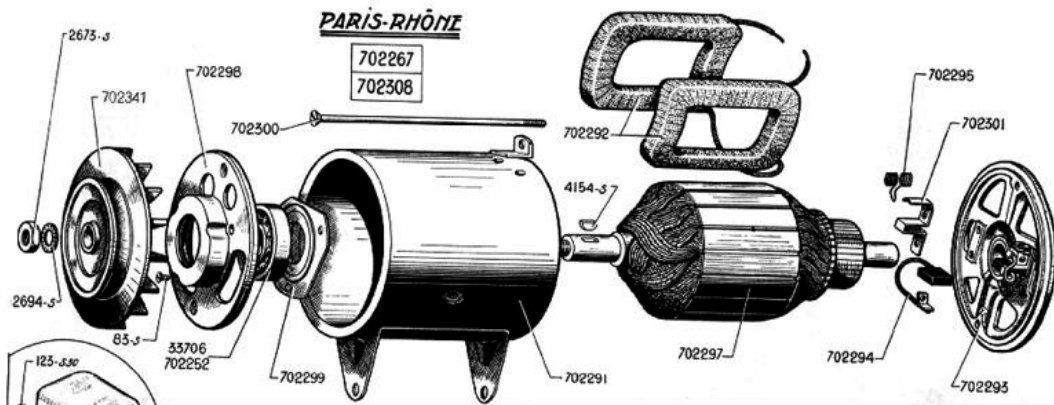

## ESSUIE - GLACE

No d'article	article		Prix CHF
721081	PROT CAOUTCH ETANCH AXE BALAI	Ø13x6mm	7.40
721113	BALAI ESSUIE-GLACE INOX	230mm	14.00
721185	BUTEE CAOUTCH MOTEUR/PLAQUE	10x6x3mm	4.10
721187/9	BAGUE CAOUTCH SUR PLAQUE SUPP	Ø15x10,5xmm	3.00
721188	ROND CUV VIS MOTEUR SUR PLAQUE	4,2x15x1	0.80
721191	ECROU COUSSINET AXE BALAI INOX	5xM8x0,75	5.40
721193	BAGUE CAOUTCH AXE BALAI	2,8x7x	0.40
721194	CANON CAOUTCH AXE BALAI S AUV	8,1x18x12,5x6mm	2.60
721195	ROND CAOUTCH AXE BALAI SUR AUV	12,5x18x3mm	1.50
721197	RONDELLE CUVETTE CHROME	8,2x18x2,5mm	3.50
721199	BAGUE CAOUTCH FIXAT DE COM.EG	Ø17x42mm	5.90
721200	ECROU SPEC COMM. ESSUIE-GLACE	5x35mm	5.50
721201	VIS COMM. ESS-GL PLANCHE BORD	M5x30	0.40
721202	BOSS PLANCHE PASS COMM. A MAIN	Ø26x19mm	18.20
721235	CANON CAOUTCHOU C EPAULE	2,5x10x14x6mm	7.40
721237	AXE DE BALAI ET LEVIER D+G	set	85.10
721237A	AXE DE BALAI ET LEVIER D+G	per Stk.	38.60
721237C	RESSORT FIX. AXE ESSUIE-GLACE		0.90
723222	TIRETTE DE COM. ESSUIE-GLACE	500 mm	19.10
807106	BRAS ESSUIE-GLACE INOX SEV	230mm	43.90
807106T	BRAS ESSUIE-GLACE TANDEM COMPL	roadstar/cabrio	212.00

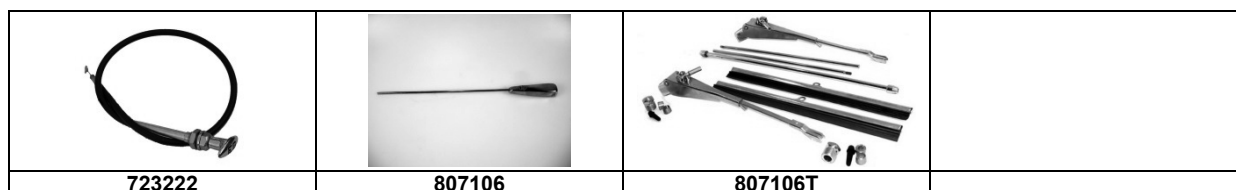
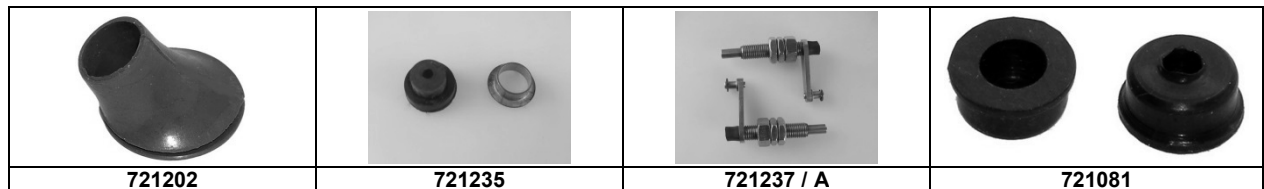
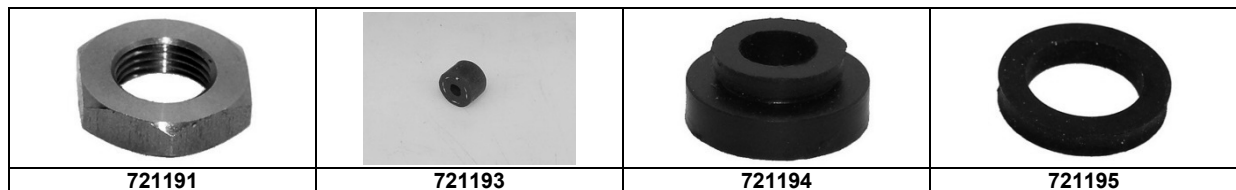
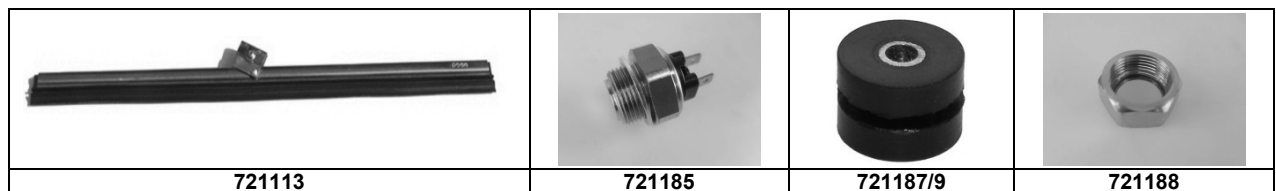

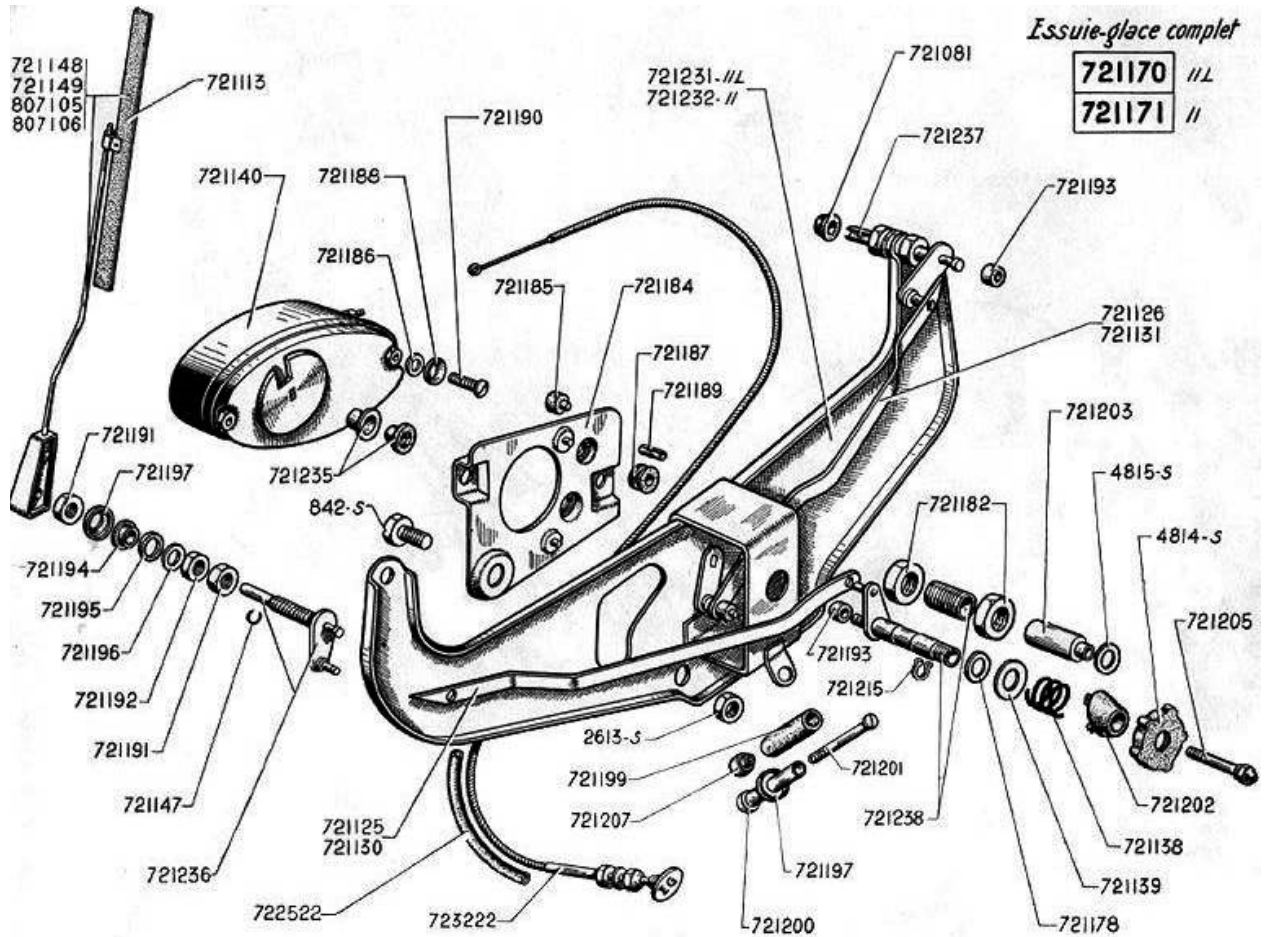

### TABLEAU LUMINEUX

No d'article	article		Prix CHF
330193	VERRE DE PROTECT.DES APPAREILS	165x120mm	20.30
330195	JONC OU CADRE CHROME	17x12,5cm	43.10
330195A	JOINT DU JONC OU CADRE CHROME	17x12,5cm	6.20
330260	CABLE DE COMPTEUR	1,750m	52.70
330278	CABLE DE COMPTEUR	1,625m	48.60
723045	CABLE DE COMPTEUR	1,685m	46.40
284000	THERMOMETRE FOND NOIR		44.50
285000	MANOMETRE HUILE FOND NOIR		44.50
286000	MANOMETRE HUILE FOND IV OIRE		44.50
283000	THERMOMETRE FOND BLANC		47.30
282000	JEU TUBE DE MANOMETER A HUILE		20.30

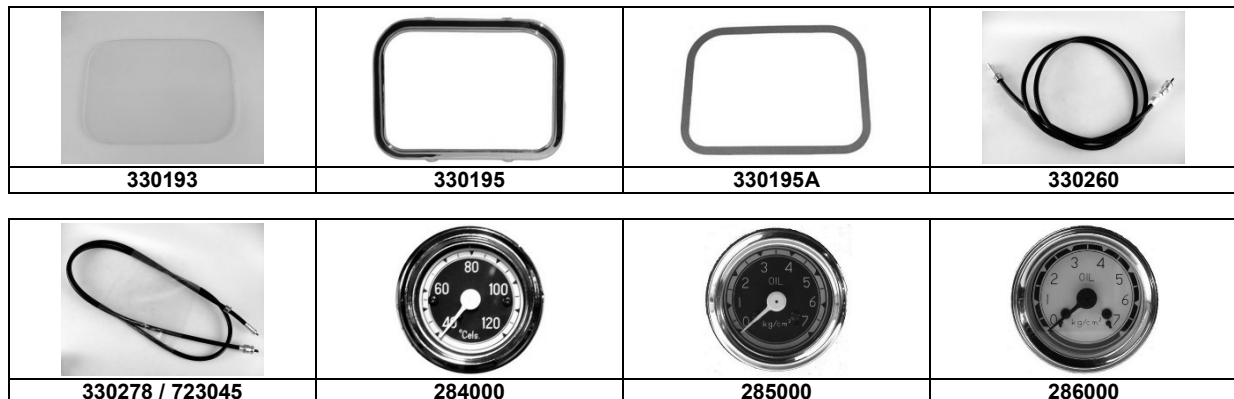

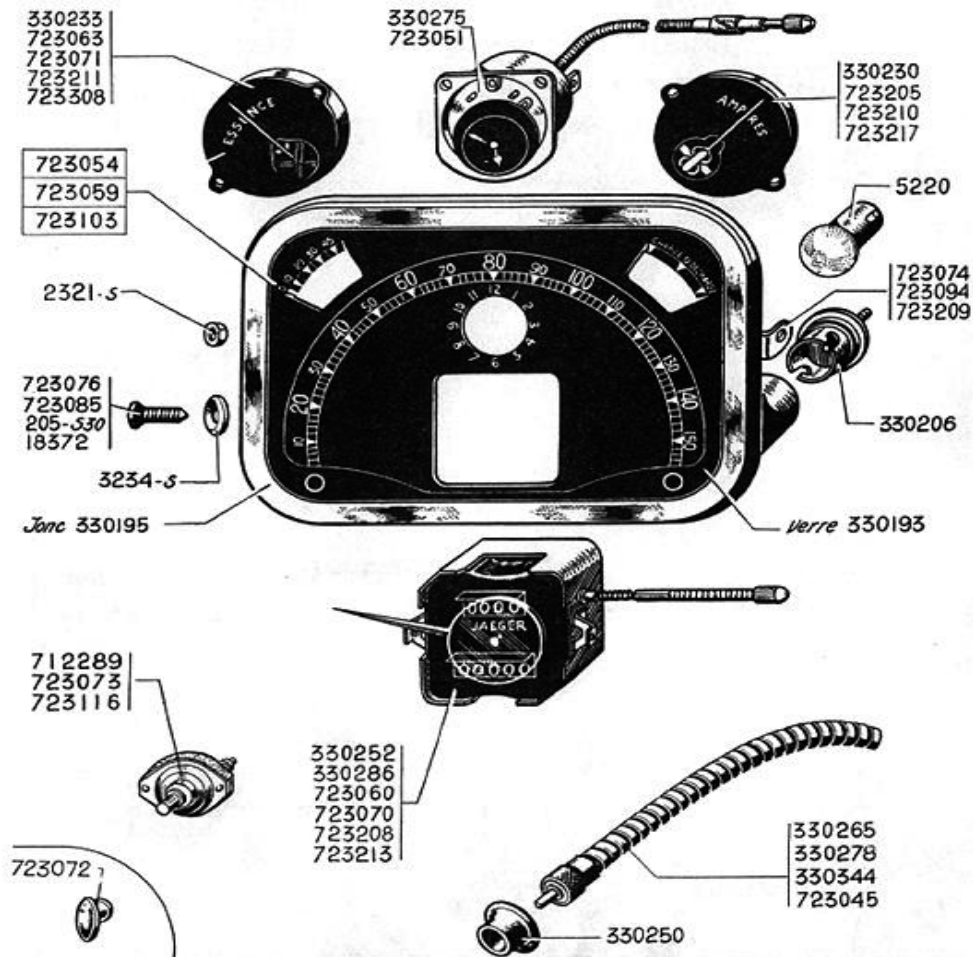



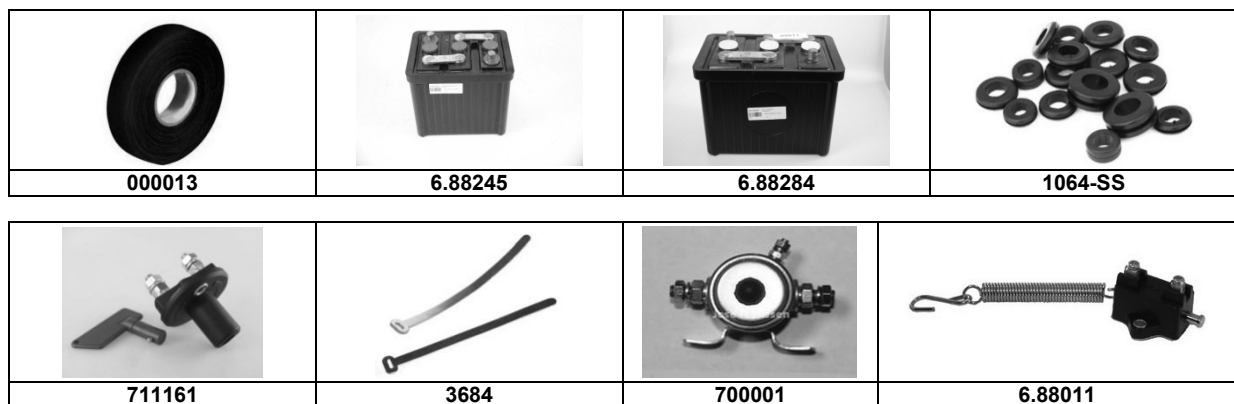

### ELECTRICITE DIVERS





No d'article	article		Prix CHF
000013	BANDE ISOLANTE TOILE	50mtrx15mm	11.90
6.88245	BATTERIE 6V-84A. SEC (DETA)	225x175x220mm	317.00
6.88284	BATTERIE 6V 110 AH	265x175x220mm	388.80
1064-SS	JEU CAOUTCH PASSE-FIL FAISCEAU	16stk/pc	20.90
3684	ATTACHES ALU. FAISCEAU ELECTR	10st.	13.40
700001	RELAIS DE DEMARRAGE 6V 200 AMP	65x90mm	52.00
6.88011	COMMANDE DE RELAIS DEMARRAGE	V700001	32.00
70001C	CLIP CABLE INT. DEMARREUR	-	4.20









## ELECTRICITE DIVERS

No d'article	article		Prix CHF
700028	CLAXON CHROME 6V	Ø125mm	58.10
700028T	CLAXON 6 V	Ø125mm	58.10
700029	CLAXON CHROME 12V BAS	Ø125mm	58.10
700029T	KLAXON CHROME 12V HAUT	Ø125mm	58.10
700039	BOITE A 6 FUSIBLES	Ø125mm	22.40
700042	COSSE CABLE DE BATTERIE 8MM	25mm <sup>2</sup>	3.70
700042A	COSSE CABLE DE BATTERIE 10MM	25mm <sup>2</sup>	2.10
700044	INTERRUPTEUR PRESSE	22mm	13.50
704250	COMMUTATEUR D ALLUMAGE AVEC BAR	19mm gat	61.10
710161	BARRETS 3 CONNECTIONS	8x2cm	17.50
710170	BARRETS 5 CONNECTIONS	12,5x2cm	22.30
711161	INTERRUPTEUR MASSE	Ø58mm	22.00
712376	CONTACTEUR DE STOP	65x41mm	19.60
712418	CONTACTEUR DE STOP	63x30mm	19.60
712426	TIGE DE CONTACTEUR DE STOP	120mm	16.20
722529	PLAQUE CABLERIE SUR JAMBON	94x76mm	16.30
722552	CABLE DE BATTERIE 40MM	380mm	19.70
722592	COSSE DE BATTERIE +	18mm	9.80
6.88029	COSSE DE BATTERIE -	16mm	7.00
722682	BARRETS 10 CONNECTIONS	18x3cm	18.60

			
<b>700044</b>	<b>700028T</b>	<b>700028</b>	<b>700039</b>



			
<b>700042 / 42A</b>	<b>722529</b>	<b>700046</b>	<b>704250</b>



			
<b>712376</b>	<b>710161</b>	<b>710170</b>	<b>722592</b>





			
<b>6.88029</b>	<b>6.68525</b>	<b>712418</b>	

## ELECTRICITE DIVERS

No d'article	article		Prix CHF
91630	RELAIS 6V/30 AMP. UNIVERSEL	6 Volt.	26.00
6.88284	BATTERIE 6v 84AH SEC		295.00
6.80019	INDICATEUR DE DIRECT. ANC. MODELL		160.00
12472	CAOUTCHOUC CLIGNOTANT PETIT		1.90
6.88035	FUSIBLES TORPEDO 16A		1.30
6.88027	COMMANDE DE CLIGNOTANT PAS ORG.		61.00
6.88034	KLAXON CHROME		31.00
711161A	INTERRUPTEUR SUR BATTERIE		22.00
704215	ECROU COMMUNTEUR PHARES	5x90	3.30
704216	VIS COMMUNTEUR PHARES	M5x30	4.60
721209	PLAFONNIER ROND A INTERRUPTEUR	Ø120mm.	20.50
704253	LEVIER COMMUNTEUR PHARE INOX	6 X 160	23.90
704211R	COMMUNTEUR NEC REP	5 Stück	35.10
6.47542	JEU ATTACHES DE CABLE 4 MM CUIVER		26.60
6.88026	COMMODO CLIGNOTANT NOIR REPLIC		49.00
6.88037	COMMODO CLIGNOTANT GRIS		54.60
700027	CLAXON NOIR 6V		52.70
6.88045	CABLE 25 mm 2 a METRE ROUGE		16.20
6.88046	CABLE 25 mm 2 a METRE NOIR		16.20
6.88013	CENTRALE CLIGNOTANTE 6 V		21.20

			
722682	711161A	91630	6.88045 6.88046

			
6.88284		6.88019	6.88027

			
721209	704253	704211R	6.47542

			
6.88026	6.88037	6.88013	

## AILES AVANT

No d'article	article		Prix CHF
2652-S	VIS FIXAT SABOT AILE AXO	1 stk/pc	0.60
298024	PLAQ TARAUEE FIXAT SUPP PHARE	15x45x5	3.90
298201B	RONDELLE DE FIXAT. DE PHARE		6.20
298202	SUPPORT DE PHARE DROIT		79.30
298203	SUPPORT DE PHARE GAUCHE		79.30
298288	JOINT CAOUTCHOUC SUPPORT PHARE		7.80
298305	PATTE ACCROCHAGE AV DU CAPOT	-	4.70
298768/9	INDEX+RESSORT ACC BIDON HUILE		20.00
298911/2R	LAQUEPROTEGE SUPPORT PHARE INF	144x90mm	3.80
299861	SABOT AILE AXO AV D COQUILLE	225x143mm	43.90
299862	SABOT AILE AXO AV G COQUILLE	225x143mm	46.10
299863	SABOT AILE AXO AR D COQUILLE	240x130mm	46.10
299864	SABOT AILE AXO AR G COQUILLE	240x130mm	43.90
299872/3	JEU BAVETTE PARE-BOUE INCLINEE	545mm	79.70
803791A	EMBOUT AILES A SOUDER D.AV	31cm	98.60
803792A	EMBOUT AILES A SOUDER G.AV	31cm	98.60
810349	SABOT AILE AXO AV DROIT	230x145mm	47.70
810350	SABOT AILE AXO AV GAUCHE	230x145mm	50.10
298768	INDEX+RESSORT ACC BIDON HUILE		18.10

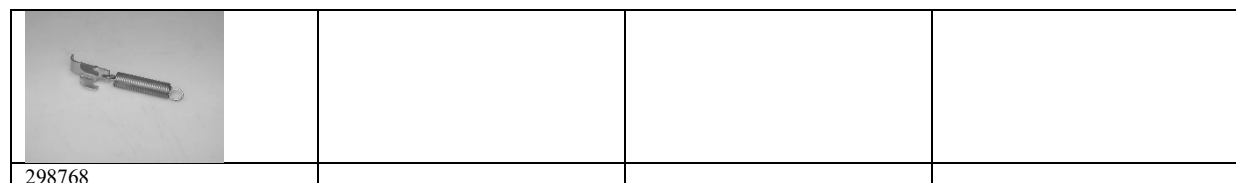
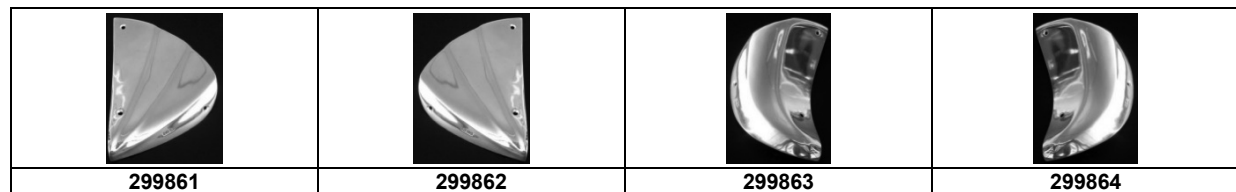
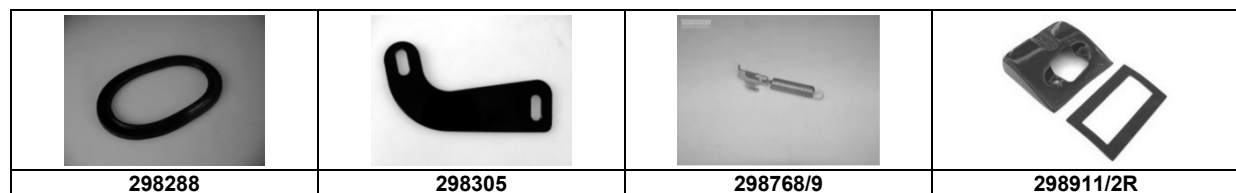
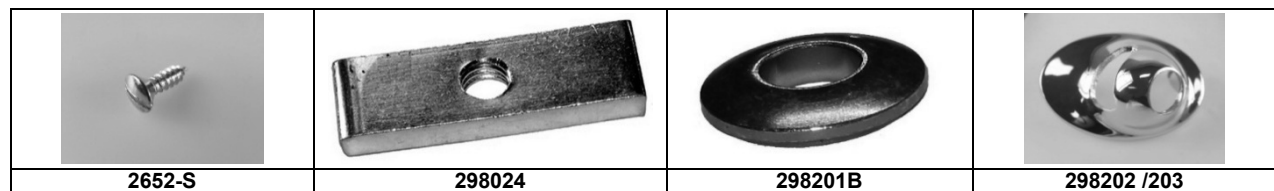

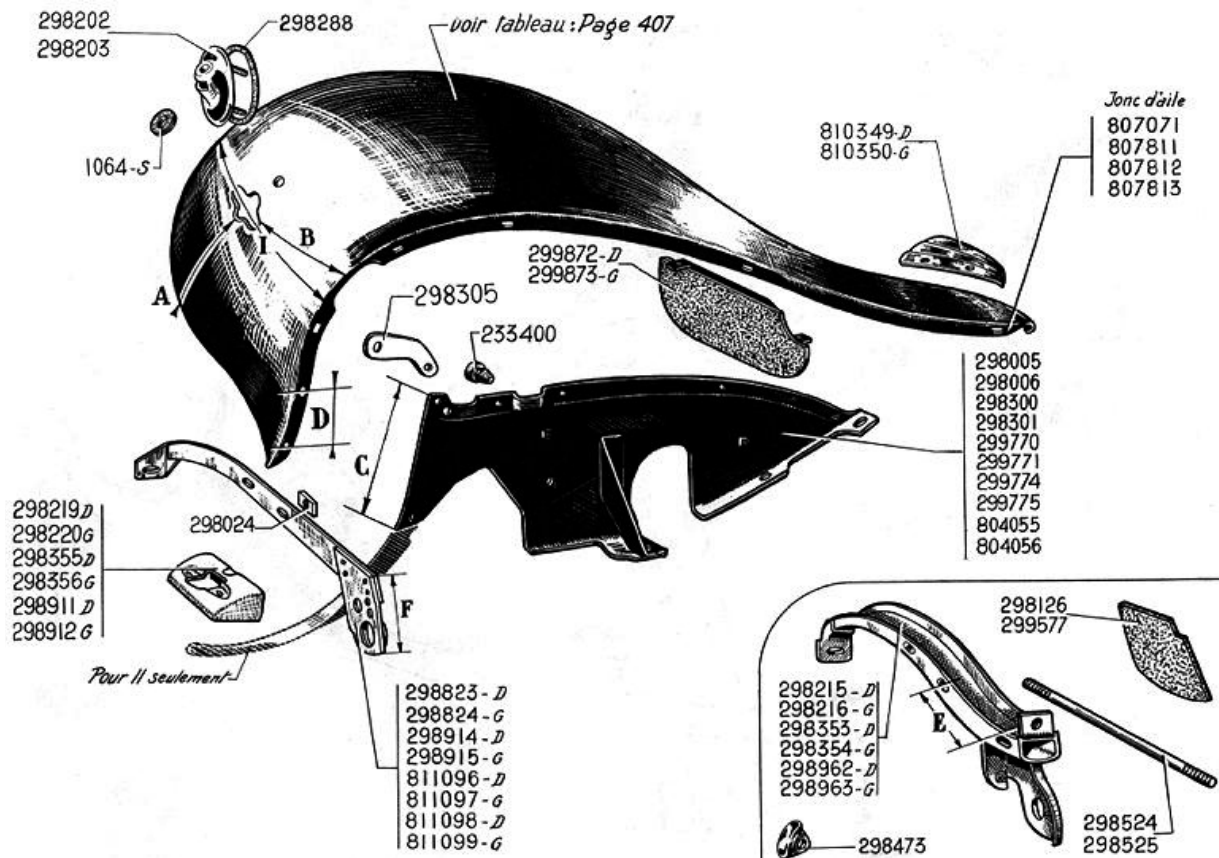

### CARROSSERIE DIVERS

No d'article	article		Prix CHF
000175A	PLAQUE DE POLICE AV		31.70
000175V	PLAQUE DE POLICE AV		35.00
190	CARROSSERIE FIXAT PARKERS	6.5 x 20	0.80
191	CARROSSERIE FIXAT PARKERS	5.6 x 16	0.80
223147	JET EAU DROIT	1,465 m.	145.70
223148	JET EAU GAUCHE	1,465 m.	145.70
232194	PLAQUE DE FOND	L=176cm	655.00
232194A	PLAQUE DE FOND	L=158cm	655.00
232194B	ATTACHER BANDES PLAQUE DE FOND	6 stk/pc	25.50
232194V	PLAQUE DE FOND PIECE AVANT	L=68,5cm	142.80
232194VL	V-PROFIL PLAQUE FOND EXT LONG	L=1700mm	18.90
232194VM	V-PROFIL PLAQUE FOND MIL PETIT	L=1605mm	18.90
232194W	PLAQUE DE FOND PIECE AVANT	L=69,5cm	142.70

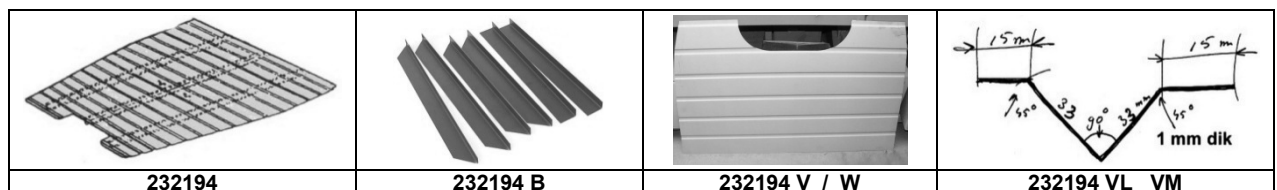
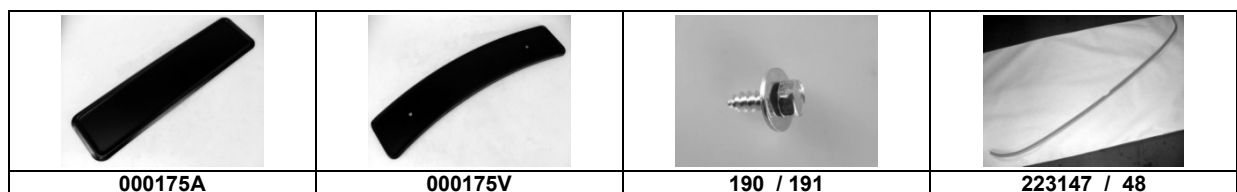

## CARROSSERIE DIVERS

No d'article	article		Prix CHF
232406	AVANT DE LONGERON DROIT	88,5x22cm	110.70
232407	AVANT DE LONGERON GAUCHE	88,5x22cm	109.40
232494	FOND DE COFFRE	108x25cm	226.80
232495	FOND DE COFFRE	116x29cm	226.80
232506D	FOND DE COFFRE	115x216mm	25.10
298590	JUPE AR TOLE MALLE PLATE	0,91mtr	122.90
298591	JUPE AR TOLE MALLE PLATE	1,01mtr	116.10
309694	BAS DE CAISSE DES PORTE AR.GAU		151.20
309695	BAS DE CAISSE DES PORTE AR.DR.		151.20
309696	BAS DE CAISSE DESS PORTE ARR.G		143.60
309697	BAS DE CAISSE DESS PORTE ARR.D		143.60
309698	BAS DE CAISSE DESS PORTE AV.G		151.20
309699	BAS DE CAISSE DESS PORTE AV.D		151.20
318344	JAMBONNEAU FOND AV GAUCHE		113.40
318345	JAMBONNEAU FOND AV DROIT		113.40
800014	TUNNEL FIXAT. SIEGES AV	114cm	244.20
800014A	TUNNEL FIXAT. SIEGES AV	126cm	212.00
803332L	PCE MONT. BOITE-ROUE PETIT INT		44.60
803332R	PCE MONT. BOITE-ROUE PETIT INT		44.60
803333L	PCE MONT. BOITE-ROUE GRAND EXT		41.90
803333R	PCE MONT. BOITE-ROUE GRAND EXT		41.90
810284	PLAQUE DE POLICE AR		62.10
299872B	BAVETTE PARE-BOUE INCL JEJ AR	400x190 mm	82.40
807811	JONC AILE NOIR 7MM	10mtr	34.30

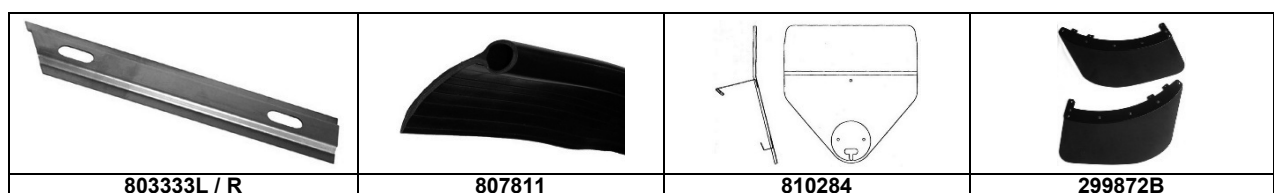
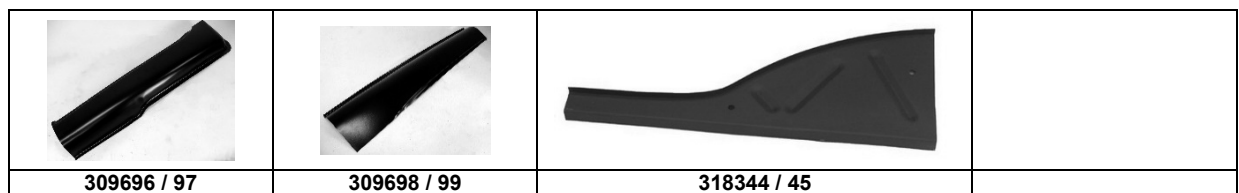
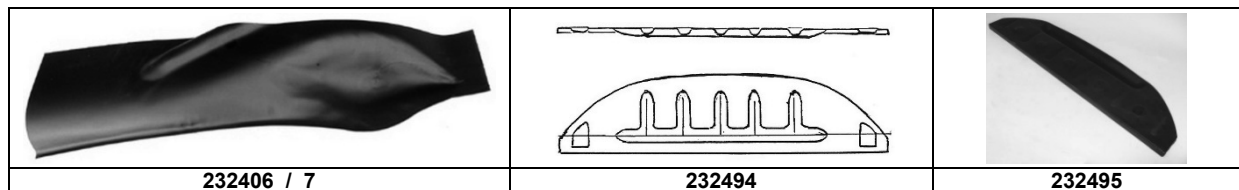

## AVANT DE CAISSE CAPOT

No d'article	article		Prix CHF
221440	CROCHET FERM. CAPOT MOTEUR		10.20
224376	SUPPORT ARR CHARNIERE CAPOT	-	35.50
232298	RONDELLE ETANCH TUBE DIRECTION	13x11cm	6.10
232300	JONC MAINTIEN RONDELLE 232298	127x48x1,5mm	5.70
2509-S30	VIS CAVALIER ET COUVRE-JOINT	M5x20	0.40
292050	POIGNEE DE VOLET DE CAPOT		35.50
298308R	BAGUETTE DE CAPOT INOX	1044x20mm	58.10
298326	CAPOT APPUI LEVIER	135x16mm	32.60
298328	GLISSIERE POUR BRAS BLOCAJE D	-	35.80
298329	GLISSIERE POUR BRAS BLOCAJE G	-	35.80
298330/1	JEU RESSORTS LEVIER CAPOT	2 stk/pc	9.90
298385	PONTET DE BAGUETTE DE CAPOT	47x25mm	31.00
298817	ARRETEUR CHARNIERE CAPOT + VIS	16x12x4mm	3.30
299760RVS	POIGNEE DE CAPOT JEU INOX		156.10
299763	RESSORT AV D/AR G RAPPEL CAPOT		9.50
299764	RESSORT AV G/AR D RAPPEL CAPOT		9.50
307909A	BAC A BATTERIE INOX	238x220x180mm	79.10
307910A	BAC A BATTERIE INOX	272x220x180mm	60.80
307917	PLAQUE AMIANTE PROT. BATTERIE	23x27cm	14.60
307917A	PLAQUE AMIANTE PROT. BATTERIE	23x23cm	8.40
309612	PASTILLE CAOUTCH SUR JAMBONN	18,5x32mm	7.10
309810	OBT CAOUT. AXES FIXAT. ESS AV	22x17,5x21,5mm	1.90
318232	BOUCH OVALE CAOUT. SUR JAMBONN	65x45x19mm	19.80

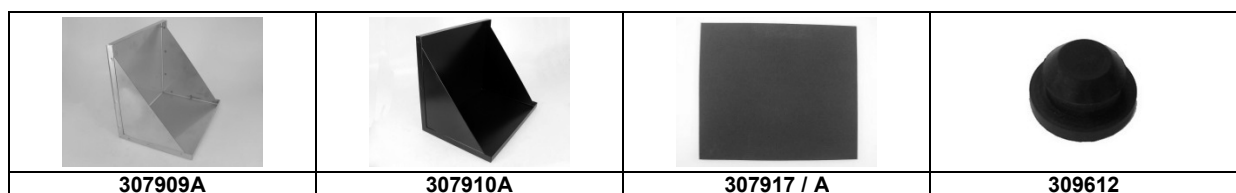
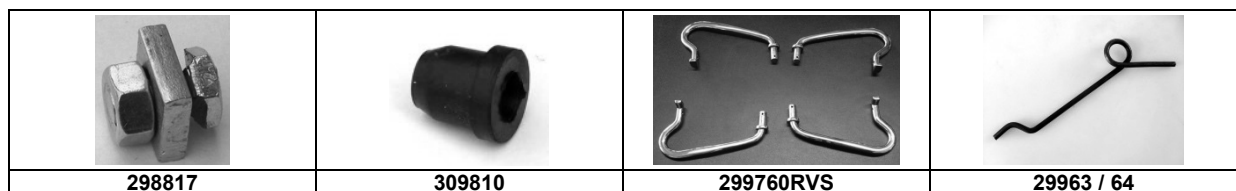
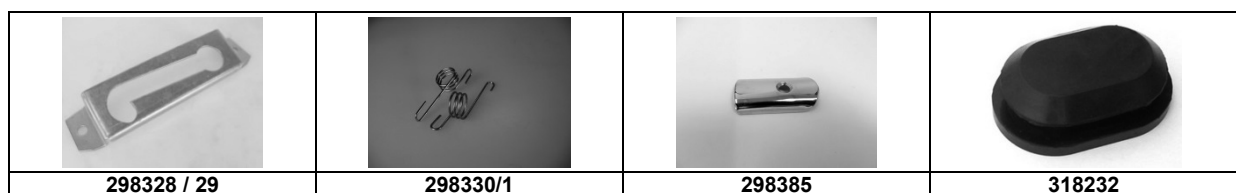
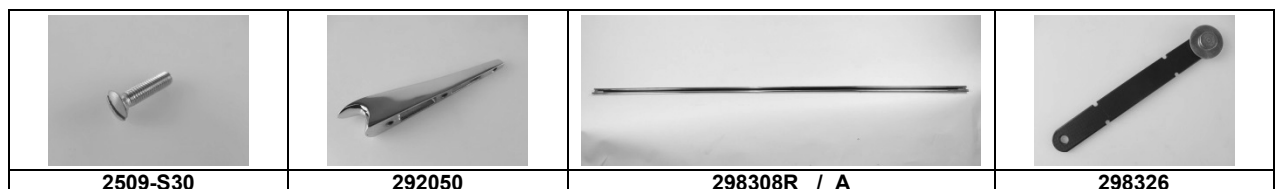
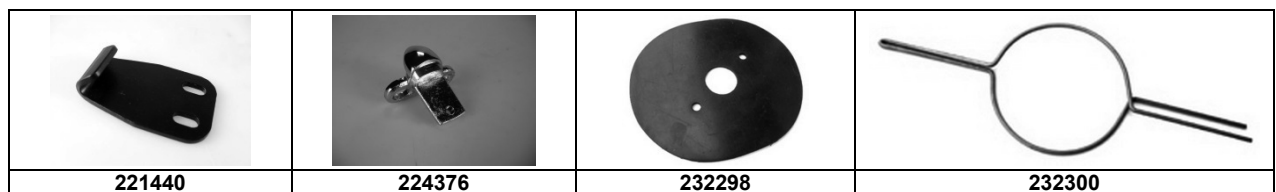

## AVANT DE CAISSE CAPOT

No d'article	article		Prix CHF
318301	TAMPON FERMETURE JAMBONNEAU D	225x130mm	33.40
318301G	TAMPON FERMETURE JAMB D +TROU	225x130xO26mm	33.10
318304	PLAQUE CAOUTCH PASSAGE TUBE	44x34x2mm	4.70
318305	TOLE MAINTIEN PLAQUE CAOUTCH	44x36x0,95mm	7.30
400019	JEU VIS SUPPORT BRAS CAPOT MOT	M5x25	7.60
711222	BRIDE DE SERRAGE DE BATTERIE	260mm	14.90
711262	BRIDE DE SERRAGE DE BATTERIE	300mm	14.90
299354	JOINT SUPPORT CAPOT-MOTEUR	-	8.20
298305	PATTE ACCROCHAGE AV DU CAPOT		4.70
298330	JEU RESSORTS LEVIER CAPOT		9.10
233400A	BUTEE VOLET DE CAPOT - 52		1.60
298308A	BAGUETTE DE CAPOT CROME		61.40

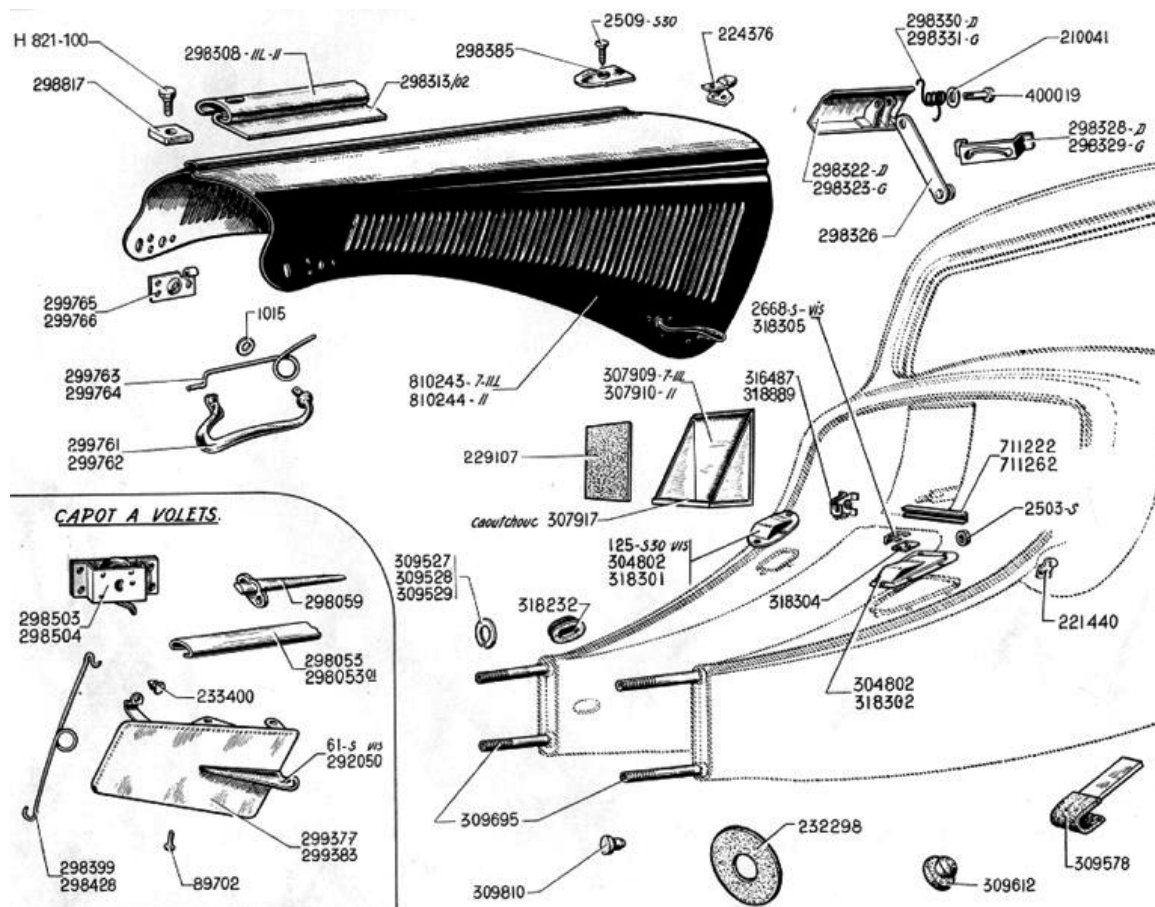
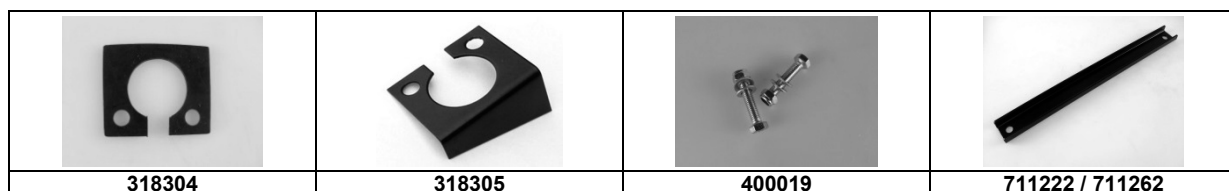
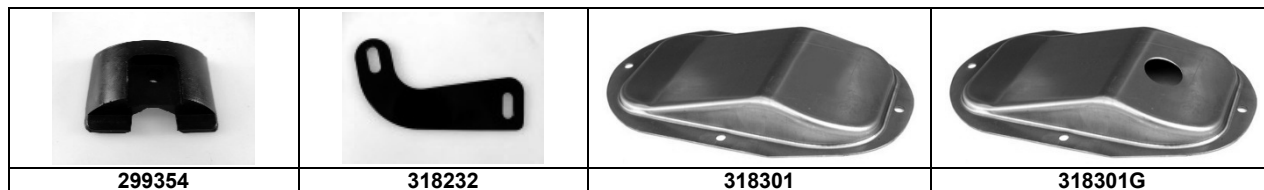

## PORTE DE COFFRE AR ET MALLE AR

No d'article	article		Prix CHF
106-S30	VIS JEU DE POIGNEE CORNE	M4x17	1.40
143188	BUTEE AV PORTE SPIDER	32x29,5x19mm	11.00
215074	JEU DE POIGNEE DE COFFRE	2stk/pc	244.30
221269A	PROFIL CAOUTCH GLACE ARR BELGE	L=183cm	27.00
224192R	CAOUTCHOUC POIGNEES DE PORTE	Ø53x4,5mm	5.90
224257	CAOTCHOUC ETANCH PORTE COFFRE	225cm	12.90
232505R	CAOUTCH ETANCH PLAQUE DE FOND		0.90
232505RA	CAOUTCH ETANCH FOND 22.5MM	Ø22,5x48,4mm	1.20
232876	CABLE DE RETENUE DE PORTE	22cm	37.90
232961	CHARNIERE DE PORTE	112x55mm	97.50
2582-S	PARKER ENCADR LUNETTE/CUSTODES	60 stk/pc	0.20
298182	JONC INOX DE HOUSSE DE ROUE	228,5x33mm	68.10
298930	VIS CENTRALE DE HOUSSE		24.40
487-S30	VIS FIXAT. DES CHARNIERES	M7x30	0.80
802676	CAOTCH ETANCH PORTE COFFRE AR	108cm	11.90
802698	AGRAFE MAINTIEN PROFILE MALLE	10x14mm	1.80
802711	TOLE NUE DE FOND DE MALLE	102x24cm	314.70
802779	JOINT DE TOUR DE MALLE	260cm	25.40
803276/7	CHARNIERE ASS PORTE CHROME	2stk/pc	92.50
803515	BUTEE TOLE APPUI ROUE SECOURS	Ø34,5x29mm	6.50
803522	JUPE AR TOLE MALLE PLATE	115x29cm	112.70
803522R	CAOUTCH TOLE HABILLAG/AILE AR	2x 220mm	2.60

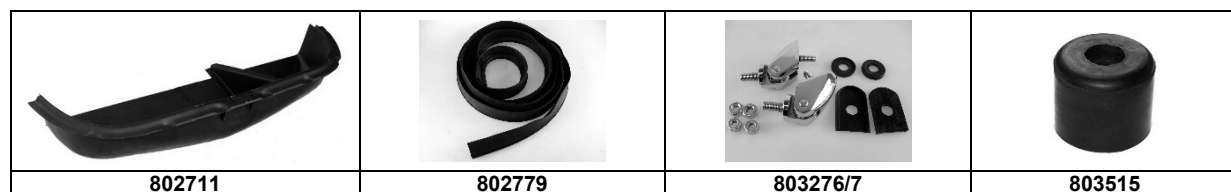
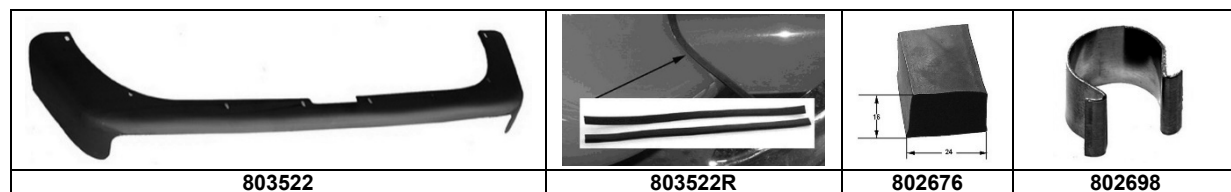
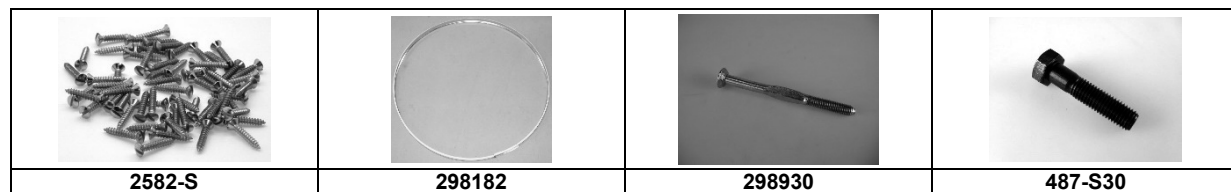
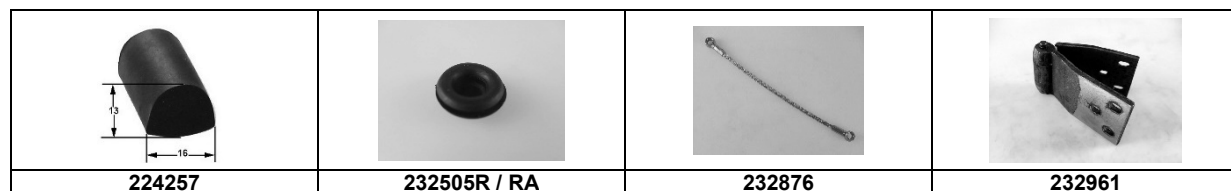
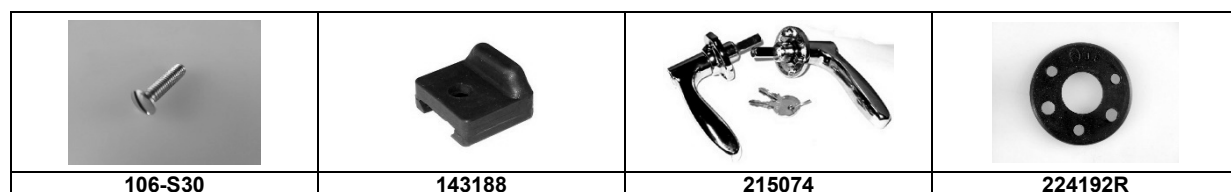

**PORTE DE COFFRE AR ET MALLE AR**

No d'article	article		Prix CHF
803568	POIGNEE DE COFFRE AR COMPL	129x26mm	118.10
803708	FERMETURE COFFRE	73x49x39mm	45.90
803709	BUTEE CAOUTCHOUC DE GACHE	22,5x16x16mm	6.50
803711	PLAQUETTE TARAUDEE FIXAT CACHE	15x76x5	4.30
803713A	PLAQUE CACHE NUE FERM MALLE	80x30x3mm	5.10
803713B	PLAQUE CACHE NUE FERM MALLE	80x30x2mm	5.10
803713C	PLAQUE CACHE NUE FERM MALLE	80x30x1mm	5.10
803716	JOINT CAOUTCH LOGEMENT RESERV	126x128mm	5.80
803718	TOLE ETANCH +JOINT CAOUTCH	12,5x10,5cm	22.10
803885	JEU SEM CAOUTCH CHARN MALLE AR	set	18.20
807811K	JOINT TOLE HAB AR FERM MALLE	32x11mm 1.30mtr	18.20
810351	SABOT AILE AXO AR DROIT	240x125mm	50.10
810352	SABOT AILE AXO AR GAUCHE	240x125mm	50.10
89274	JEU VIS SERRURE DE PORTE	M5x13	0.40

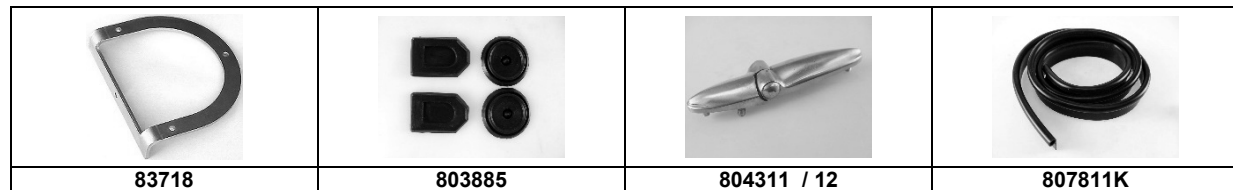
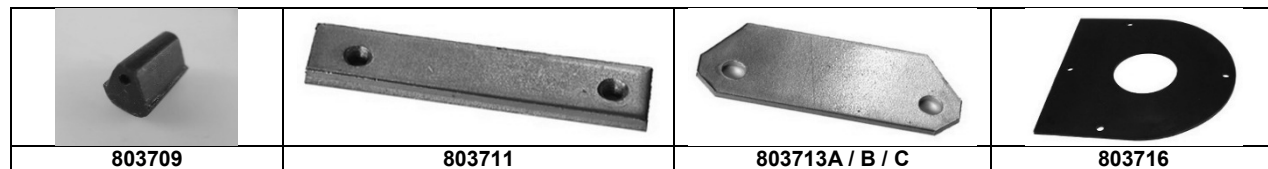
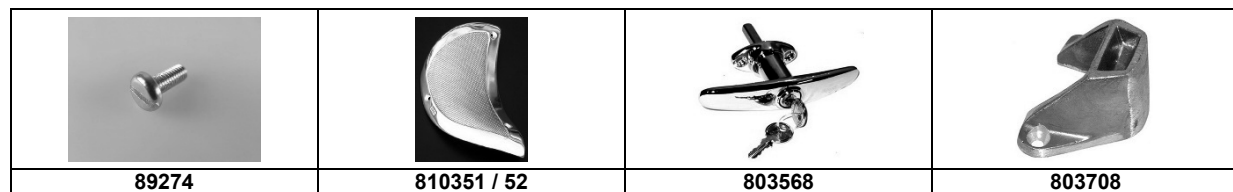

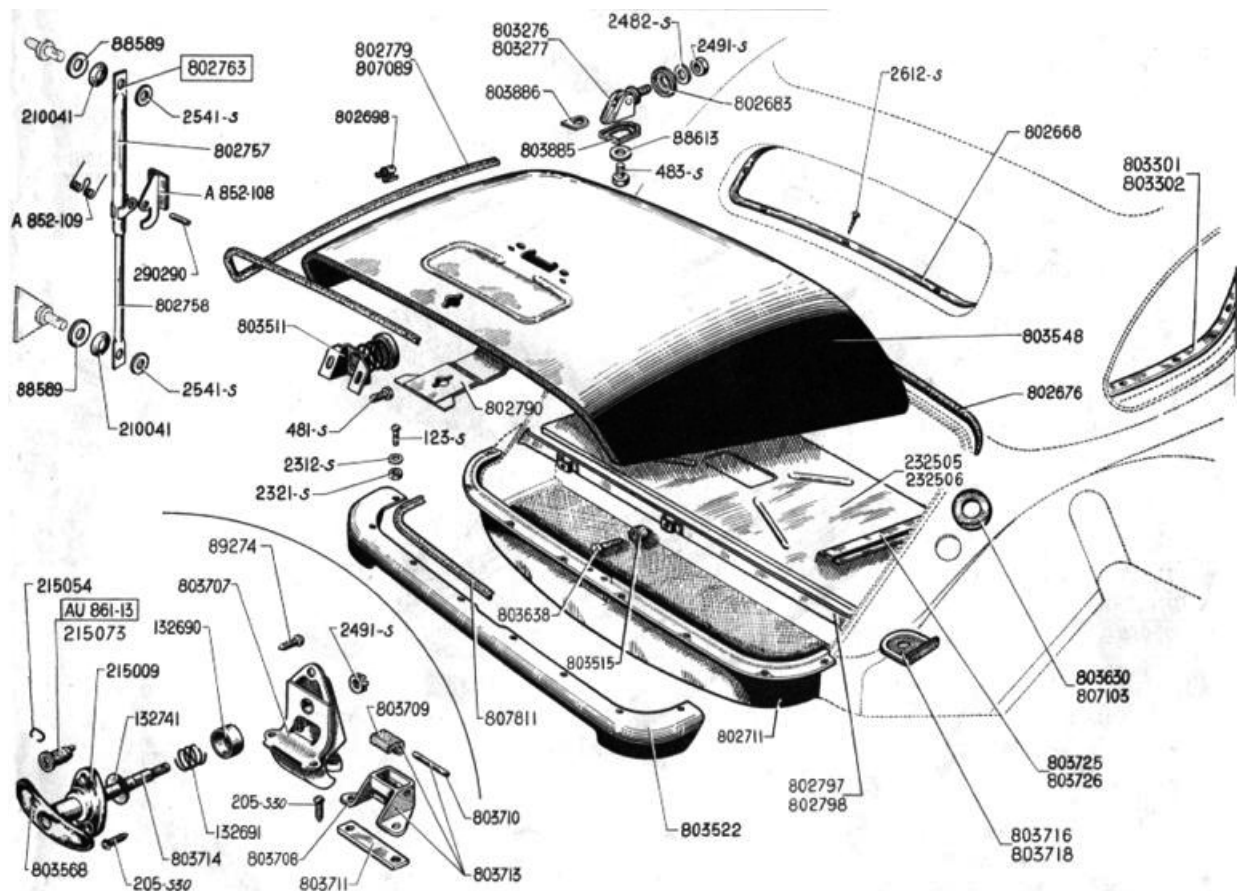
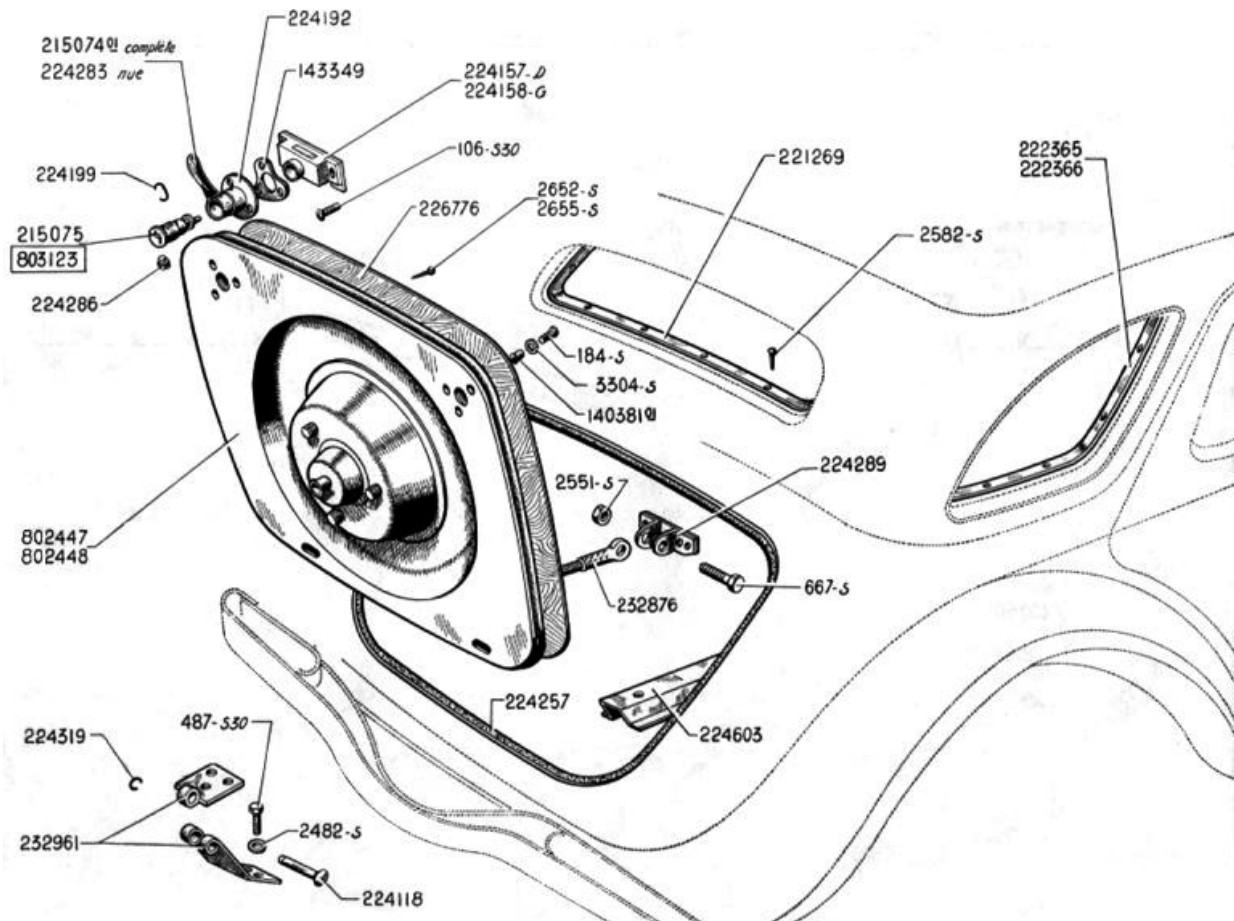

## PORTE

No d'article	article		Prix CHF
133838	MANIVELLE DES LEVE-GLACES	96mm	32.40
159-S	VIS BUTEES DE CALE-PORTES	16stk.5x25mm	0.30
216013	BOITE DE CALE-PORTES NOIR	53x43x14mm	18.30
216013A	BOITE DE CALE-PORTES CHROMEE	53x43x14mm	19.20
216146	JEU A GRAFES COULISSES GLACES	33x18mm 24stk/pc	15.50
216179	PROFILE SCELL GLACES DE PORTES	65cm	9.50
216183	BUTEE CAOUTCHOUC CALE-PORTES	55x33x24mm	10.80
216235	BUTEE TIRANTS PORTES CAOUTCH	Ø26x16mm	4.60
221336A	CONTREPLAQUE REGL CHARNIERES	55x38,5x0,75mm	8.90
221336B	CONTREPLAQUE REGL CHARNIERES	55x38,5x1mm	8.90
221336C	CONTREPLAQUE REGL CHARNIERES	55x38,5x1,5mm	8.90
222121	COULISSE DES GLACES		14.20
222740	JEU JOINT ETANCH HAUT PORTES 4	510cm	36.50
222925	JOINT CAOUTCHOUC GLACES PORTES	640x28x2	7.30
224040D	PLAQUE ANTI VIBR INT DE PORTE	50x22,5cm	21.80
224042BP	JEU REPARATION PORTE INT. AV D	90,5x16cm	147.20
224042SP	JEU REPARATION PORTE EXT. AV D	92x56cm	334.80
224043BP	JEU REPARATION PORTE INT. AV G	90,5x16cm	143.00
224043SP	JEU REPARATION PORTE EXT. AV G	92x56cm	333.50
224044BP	JEU REPARATION PORTE INT. AR G	57x23cm	147.20
224044SP	JEU REPARATION PORTE EXT. AR D	80x54cm	351.00
224045BP	JEU REPARATION PORTE INT. AR D	57x23cm	147.20
224045SP	JEU REPARATION PORTE EXT. AR G	80x54cm	330.80
224046BP	JEU REPARATION PORTE INT. AR D	75,5x14cm	143.00

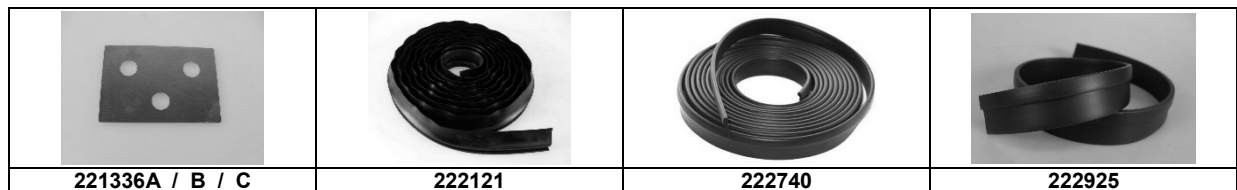
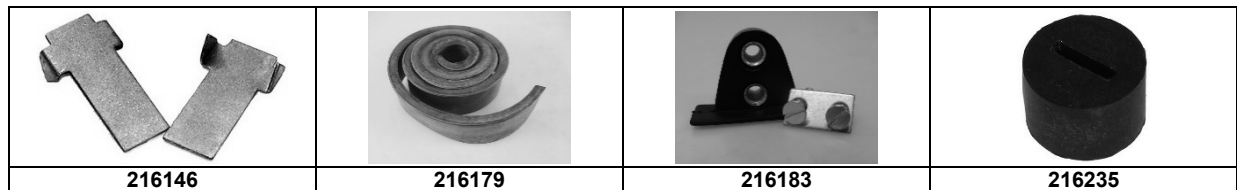
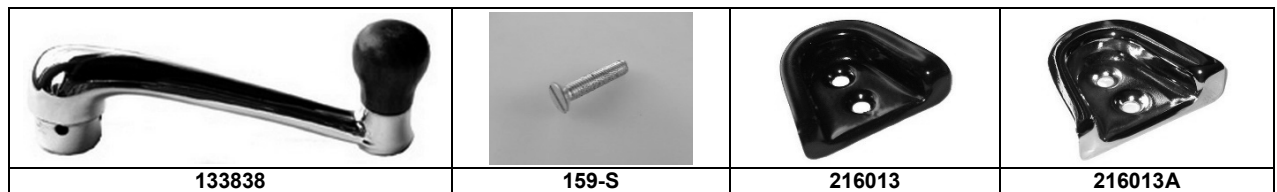

## PORTE

No d'article	article		Prix CHF
224046SP	JEU REPARATION PORTE EXT. AR D	85x54cm	340.60
224047BP	JEU REPARATION PORTE INT. AR G	75,5x14cm	131.20
224047SP	JEU REPARATION PORTE EXT. AR G	85x54cm	333.50
224118	AXE CHARNIERES DE PORTES 7MM	Ø7x60mm	10.40
224118A	AXE CHARNIERES DE PORTES 7.5MM	Ø7,5x60mm	8.80
224118B	AXE CHARNIERES DE PORTES 8MM	Ø8x60mm	8.40
224644	BUTEE GUIDE-GLACE DE PORTES	19x8x6mm, 6stk/pc	5.10
232004	CHARNIERE DOUBLE DE PORTES	-	135.00
232004B	CHARNIERE DOUBLE DE PORTES + AXE 7MM		103.00
232772	TIRANT DE PORTES	110x15x37mm	13.90
233400	BUTEE ANTIBRUIT	Ø20x19mm	1.90
244-S	VIS OUVRE PORTE/LEVE-GLACES	M6x15	1.40
807102	COULISSE GLACES JEU 4 PORTES	840cm	62.10
83-S	VIS FIXAT BOITES CALE-PORTES	16stk.4x10mm	0.20
89847	RONDELLE ELASTIQUE CHARNIERES	Ø14x4mm	0.90
951018	CADRE JOINT ETANCH HAUT PORTES	5x11mm L=85cm	19.80
100021S	JEU VIS ENCADREMENT VITRE ARR	3,5x13: 10 stk/pc	0.40
132232	RESSORT RAPPEL COMM A DISTANCE		7.50
132513	POIGNEE INTERIEURE DES PORTES	108mm	26.60
132808	EMBASE POIGNEES INTERIEURES	Ø45x10mm	5.50
132808A	DOUILLE POIGNEE INT	3x16mm	0.90

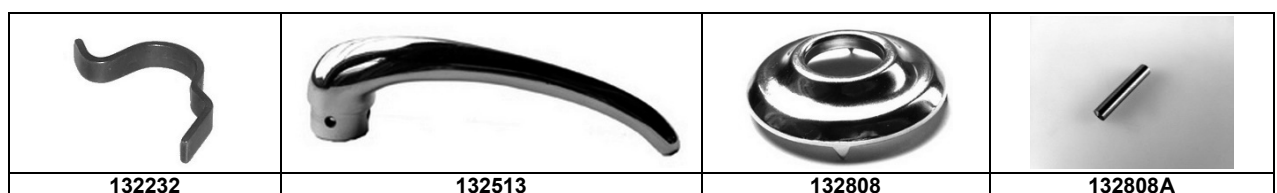
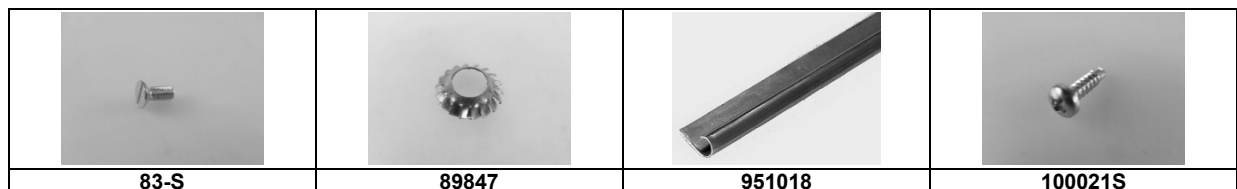
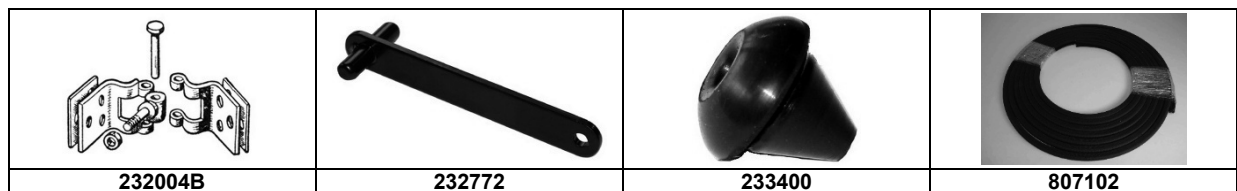
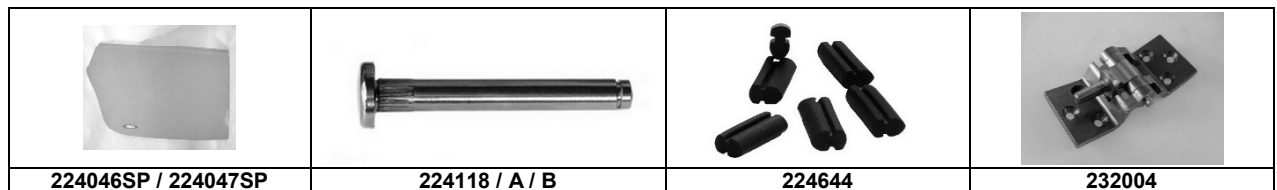
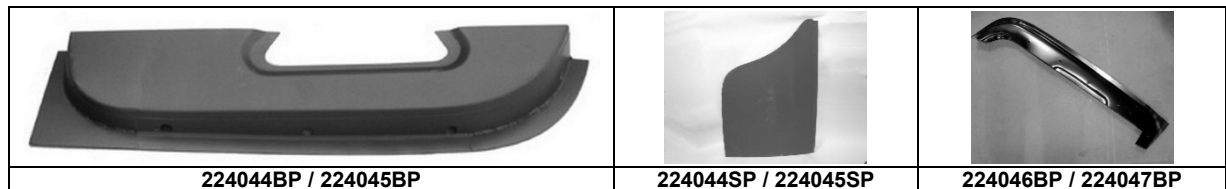

## PORTE

No d'article	article		Prix CHF
133841	RESSORT EMBASES POIGNEES INT	Ø40x26mm	3.20
210004PL	PIECE REPARATION SERRURE PORTE	Ø25x26mm	9.30
210046R	BARRE SERR CAOUTCH 210045/6	17cm	1.50
215001	POIGN EXT AV G/AR D SANS COND	113x29mm	79.40
215002	POIGN EXT AR G SANS CONDA MN	113x29mm	79.40
215009	ENTREE DES POIGNEE DE PORTES	40x11mm	17.80
215009A	CAOUTCHOUC DE PIOGNEE DE PORTE	60x35x5mm	2.30
215009P	PLAQUE/ECROU POIGNEE PORTES	30x53mm	10.70
215071	POIGN EXT PORTE AV D SANS BAR.	113x29mm	122.90
215071L	JEU DE POIGNEE DE PORTE AV G	113x29mm	122.90
216182	GACHE FIXE REGLABLE SERRURES	68x32x16mm	35.10
244-S10	VIS DES LEVE-GLACES/SERRURES	M6x15	1.10
2516-S30	VIS DE FIXAT DES PIOGNEES	M5x16 10stk/pc	1.50
802942	BAGUETTE DE PORTES ALUMINIUM	795x10mm	25.70
802943	AGRAFE MOTIFS DE PORTES (4)	20 stk/pc	9.00
89303	VIS GACHES/CHARNIERES (232004)	M7x12	2.90
89320	VIS GACHES	M7x16	3.90
89411	VIS GACHES/CHARNIERES (232004)	M7x20	4.60
89411A	VIS CHARNIERES M8X16	M8x16	1.90
89411B	VIS CHARNIERES M8X20	M8x20	1.90
222925B	BAVETTE BAS DE PORTES JEU		34.50
803125	JEU DE 3 BARILLETS 2CV		34.60
803124	JEU DE BARILLETS 2 CLÉS (5 PIÉCES) 7.52 -		44.00
803123	JEU DE BARILLETS AVEC 2 CLÉS (3 PIÉCES)		30.40
216170	BAS DE GLACE DE PORTE		63.50
222925BL	BAVETTE BAS DE PORTES JEU BL		31.10
222925S	JOINT CAOUTCHOUC GLACES PORTES JEU		28.40

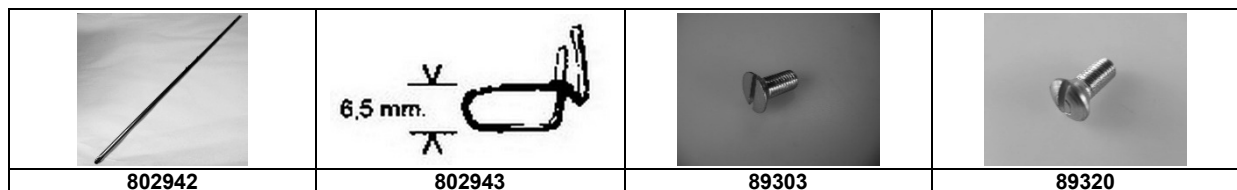
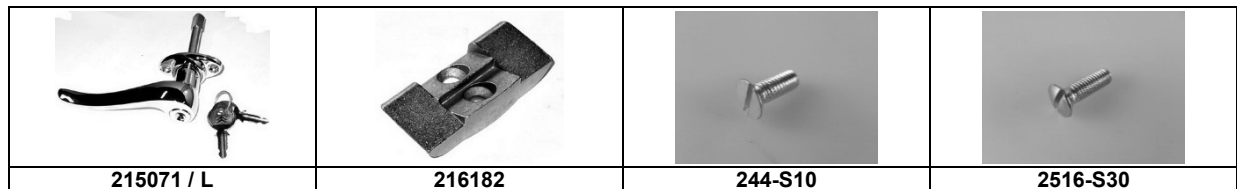
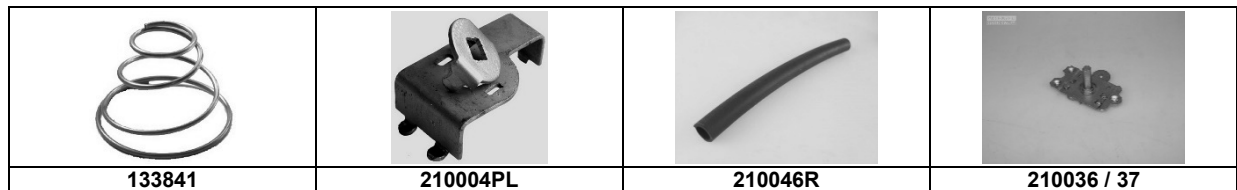

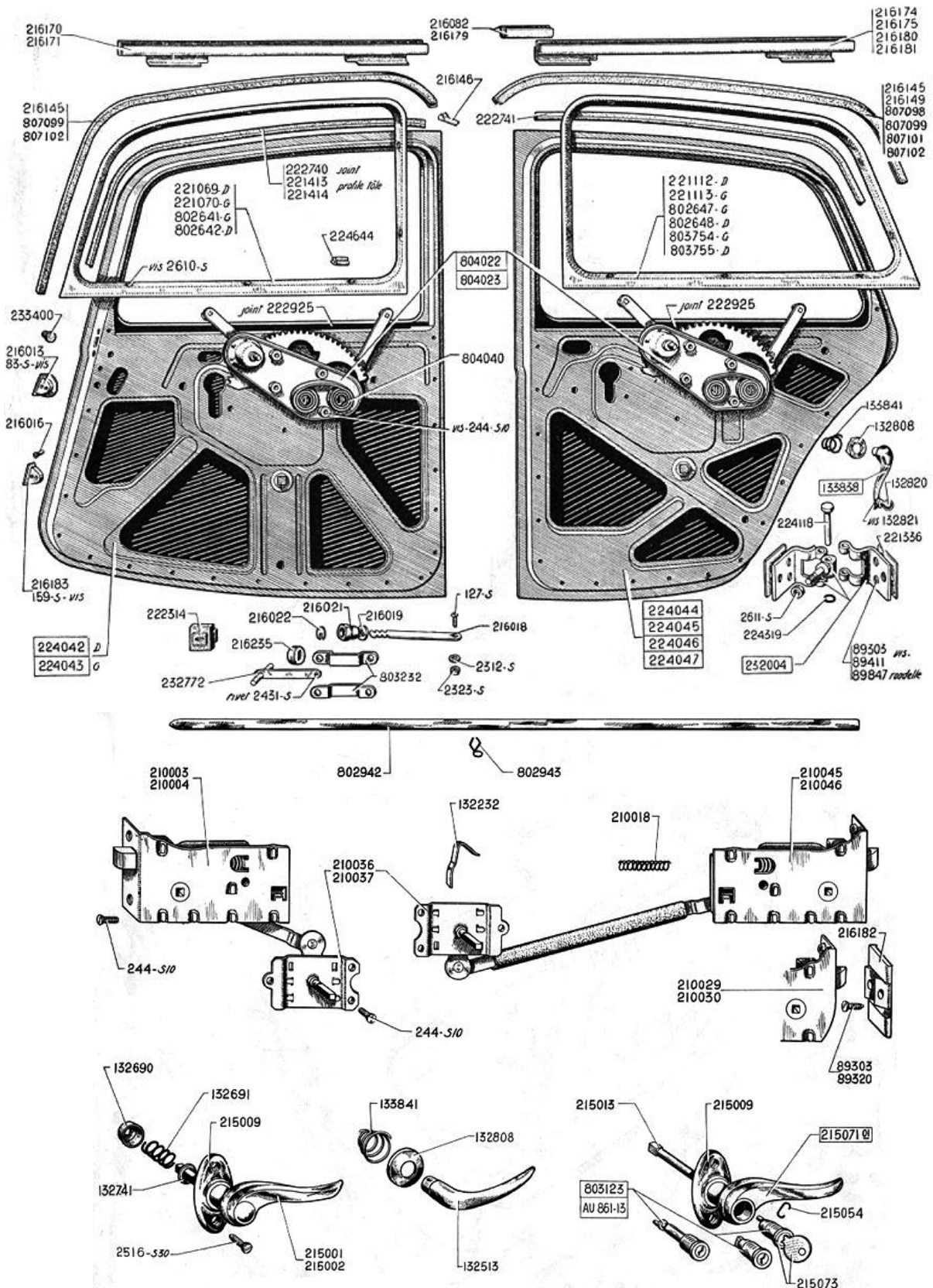
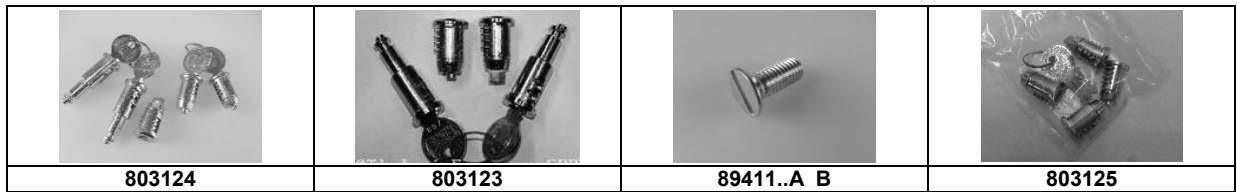

## PARE - CHOCS

No d'article	article		Prix CHF
248-S	VIS FIXAT. SUPPORT MANIVELLE	M6x25	0.90
291591	VIS CHROMEE PARE-CHOCS INOX	M8x25	9.50
298075	JOINT ETANCH SUPP P-CHOC AR G	128x35x30mm	10.10
298076	JOINT ETANCH SUPP P-CHOC AR G	128x35x30mm	10.10
298000	ENTRIER PARE-CHOCS SET AV+ AR BN - 52		307.00
298001	ENTRIER PARE-CHOCS SET AV BL 52 -		399.00
298003	ENTRIER PARE-CHOCS SET AV BN 52-		371.00
298004	ENTRIER PARE-CHOCS SET AR BN 52-		492.00
298041	PARE-CHOCS AVANT	154x6.5cm	285.00
298260	PARE-CHOCS AVANT	168x7.5cm	285.00
298265	PARE-CHOCS ARRIERE	168x7.5cm	285.00
298281	PARE-CHOCS ARRIERE	154x6.5cm	285.00
298553	SUPPORT DE MANIVELLE	71x46mm	13.70
299317	TAMPON SUR PARE-CHOCS AV/AR	190x45mm	55.40
6.72208	PLAQUETTE PARE-CHOC ARR.	25x140mm	16.40
299806	SUPPORT DE PARE-CHOC AV D.	430x187mm	91.80
299807	SUPPORT DE PARE-CHOC AV G.	430x187mm	91.80
301630	ECROU-CHAPEAU M8	M8	1.20
759-S30	VIS ROSETTE PARE CHOC	M8x30	0.60
811070	PARE-CHOCS ARRIERE	148x6.5cm	285.00
811072	PARE-CHOCS ARRIERE	162x7.5cm	285.00
811108	PARE-CHOCS AVANT	148x6.5cm	285.00
811071	PARE-CHOC AVANT B 52 - >		285.00

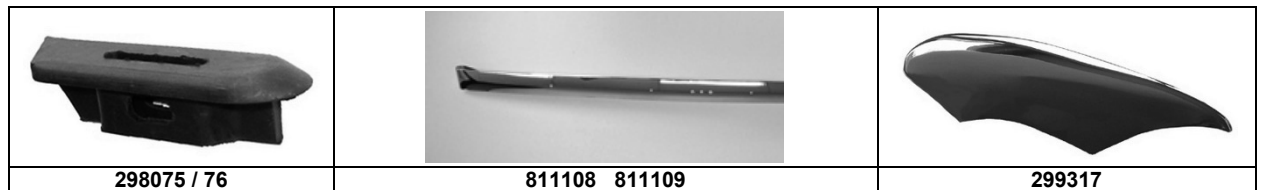
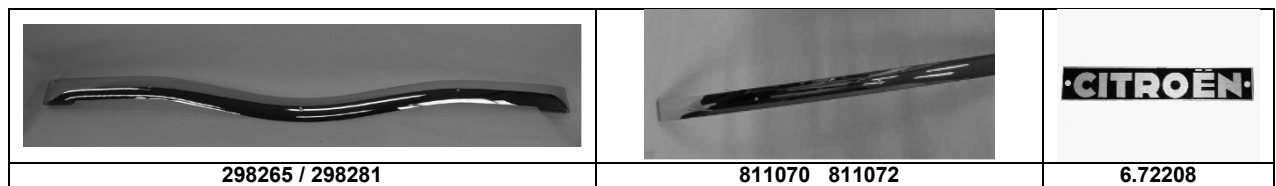
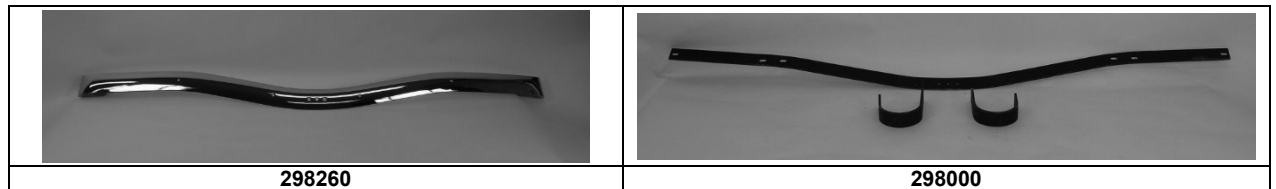
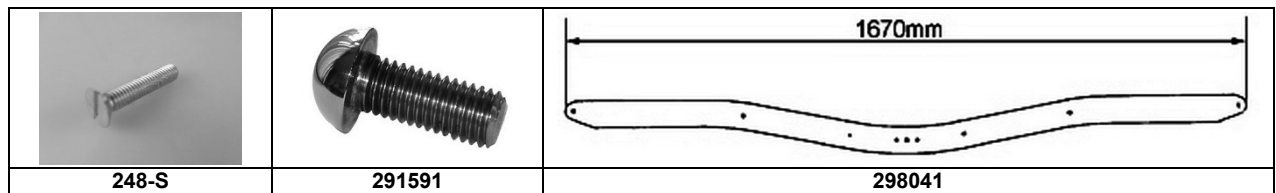

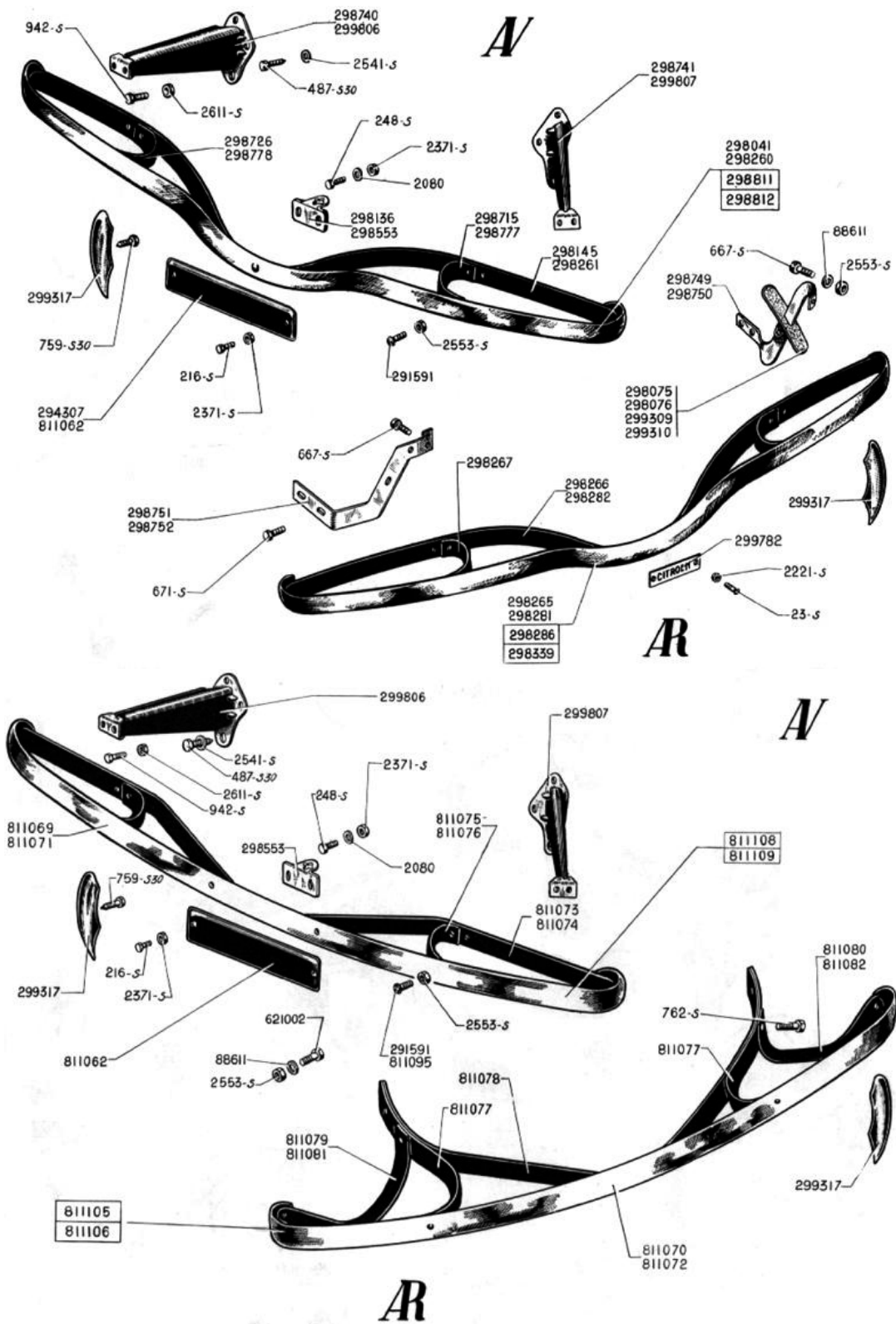

## CHAUFFAGE A AIR

No d'article	article		Prix CHF
302771	COLLIER DE SERRAGE DES DURITS	8mm	4.30
329875	DURITE DE CHAUFFAGE COUDEE	O84x147mm	17.60
329880	OBTURATEUR AIR	O79x69mm	55.70
329885	CAOUTCHOUC OBTURATEUR AIR	O78x68x5mm	8.50
329907R	STORE DE RADIA TEUR	44cm	249.80
329907RL	STORE DE RADIA TEUR	39cm	261.50
329917	CAPTEUR DE PRISE AIR	28x11,5cm	59.40
329922	TUBE DE CHAUFFAGE	550x85x40mm	45.00
331190	CLAPET CONDUIT CHAUFFAGE	O84x12x3mm	20.00
331245	RESSORT CLAPET DU CHAUFFAGE	430mm	26.70
331352	DURITE CHAUFFAGE DR. 11/15CV	100x44mm	10.10
451542	RACCORD-T TUYAU DE CHAUFFAGE	35x15x35mm	102.50
600303K	ROBINET CHAUFF COMM. PAR CABLE	15mm	52.20

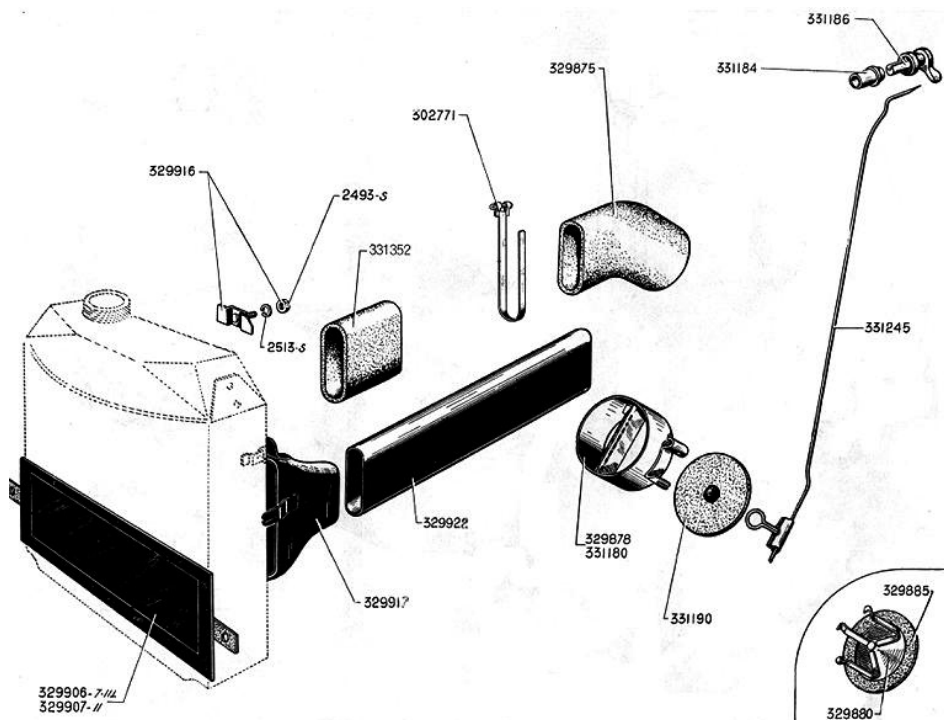
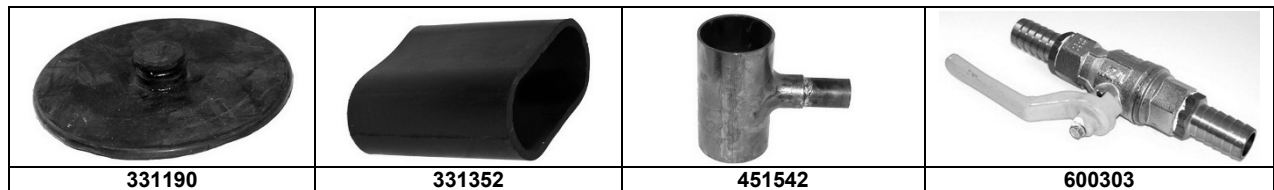
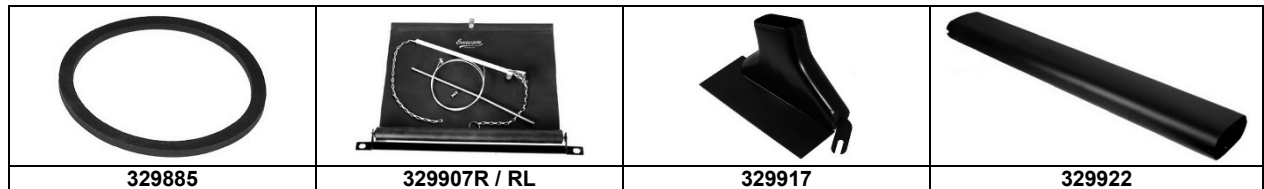
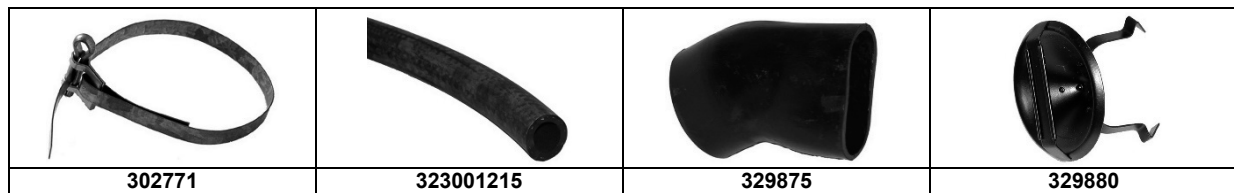

## AUVANT

No d'article	article		Prix CHF
1061-S	ROND CAOUTCH ANTIBR COMM AERAT	Ø14x8x4mm	1.00
216107	JEU DE TRESSE A CAPOT NOIR	210cm	22.80
221134	JOINT DE VOLET AERATEUR AUVENT	295x80x12mm	20.10
221153	VIS COMMANDE VOLET AERATEUR	Ø8x110mm	19.90
221333	ECROU COMMANDE VOLET AERATEUR	Ø22x26mm	18.00
221795	BUTEE VOLET BOITE A GANTS	Ø5x8mm	4.60
221811	BOUTON COMMANDE VOLET AERATEUR	62x41x7,5mm	15.40
223678	RESSORT BOITE A GANTS		10.60
224360S	AUTOCOLLANT VOLET BOITE GANTS	26x7cm	7.60
224360SA	AUTOCOLLANT VOLET BOITE GANTS	26x7cm	7.60
224360SB	AUTOCOLLANT VOLET BOITE GANTS	26x7cm	7.60
224377	TRAPPE AERATEUR +ECROU	290x53mm	187.20
224381	TUBE DE TIGE COMMANDE DE VOLET	Ø10x145mm	13.50
224612	TUBE CAOUT EVAC EAU PARE-BRISE	2mtr	44.60
2654-S	VIS PARKER DE TRESSE DE CAPOT	stk/pc	0.50
723072	BOUTON OVAL TABLEAU DE BORD	11,6x31mm	15.10
802594	MOTIV CENTRAL DOUBLE CHEVRONS	38x40mm	19.00
803046	CARTON DE BOITE A GANTS	325mm	106.00
803265	CLAPETTE VENT. PART DE CARR	32x11cm	20.50

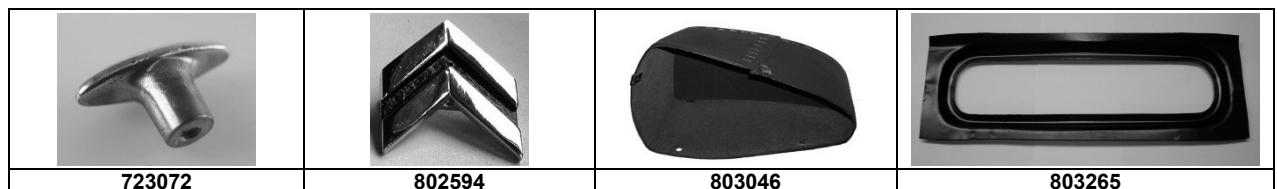
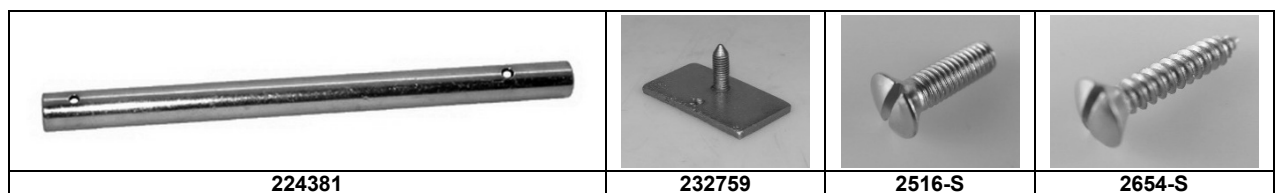
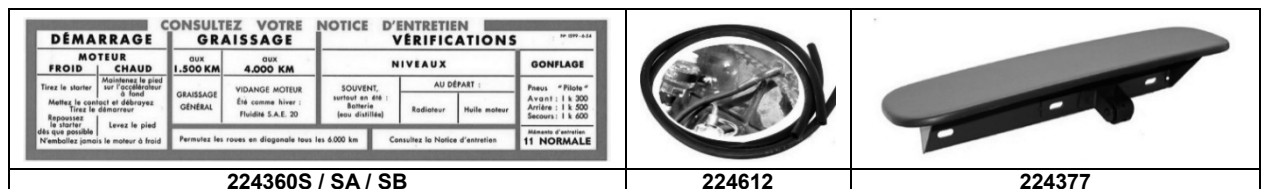
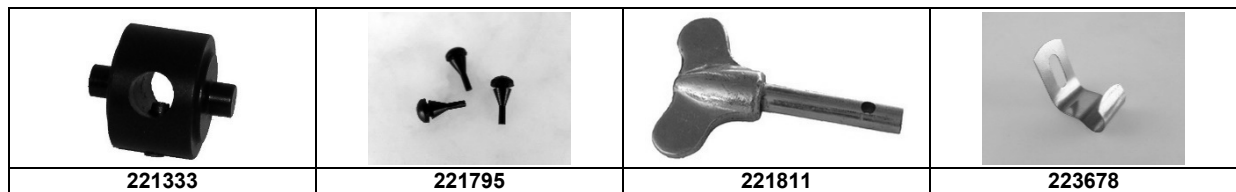
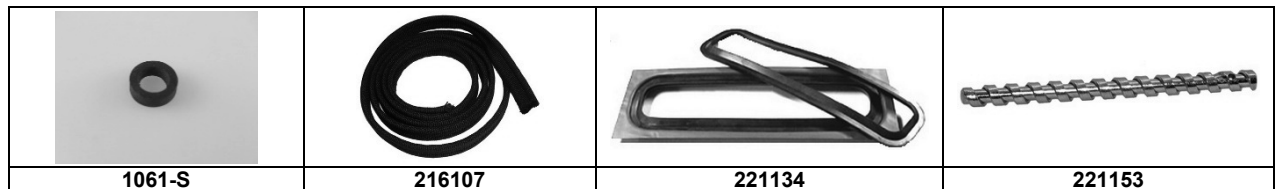

## AUVANT

No d'article	article		Prix CHF
803545	CENDRIER COMPLET.	-	34.00
804097	TRAPPE AERATEUR +ECROU	290x38mm	201.00
88558	ROND FIBRE BUTEE COMM. AERAT	Ø18x8,5x1	1.00
216107A	JEU CLOU FIX DE TRESSE A CAPOT	3x9,5mm 10stk/pc	12.20

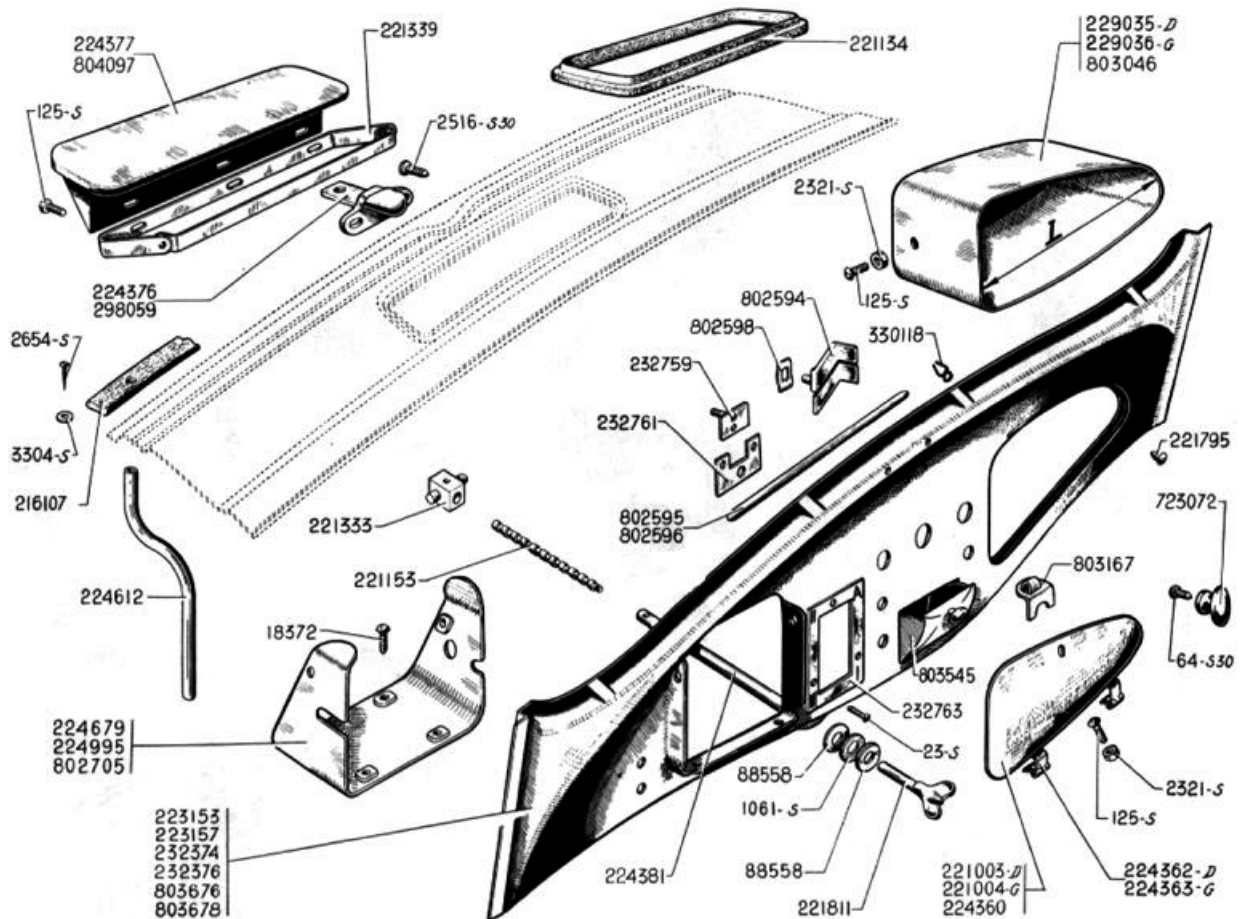
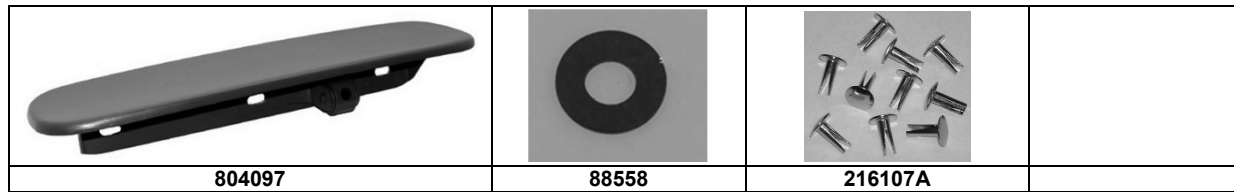

## PARE BRISE

No d'article	article		Prix CHF
213038	JOINT INFERIEUR DE CADRE	1,055m	25.40
213113	JOINT DE CADRE PARE-BRISE	24x8x2850mm	24.30
213122	JOINT INF CADRE	1,175m	27.00
213201	COUVRE CADRE PARE-BRISE	7x21mm	5.20
622519	JEU VIS SCHARNIERE PARE-BRISE	M5x10	0.30
802438	COUVRE-JOINT MOULURE BAIE AV	28,5x26mm	9.80
802528	SUPPORT RETROVISEUR INT.	-	18.70
803521	COUVRE-JOINT MOULURE BAIE AV	60x41mm	20.70
804008	RENF CENTR COMM PARE-BRISE 2TR		4.70
804102	TUBE ECROU COMM PARE-BRISE	71,5mm	102.80
804104	BOUTON CAOUTCHOUC COMM VOLET	-	4.50
804109	COLL COUVRE INF COM PARE-BRISE	Ø32x17x11mm	19.20
804110	COMM.CENTRALE PARE-BRISE	-	96.80
804112	BUTEE ENTRE ENCADREMENT BORD	64x20mm	11.40
102-S	VIS ASSEMBLAGE DES CADRES	8xm4x7,5	0.40
121222	PROF CAOUTCH SCHELLEMENT GLACE	275cm	21.60
213203/4	PROFILE ETANCHEITE PARE-BRISE	285cm	17.40
213203/4A	PROF ETANCH PARE-BRISE SPECIAL	280cm	43.90
216160A	RETROVISEUR INTERIEUR	127x55mm	79.70

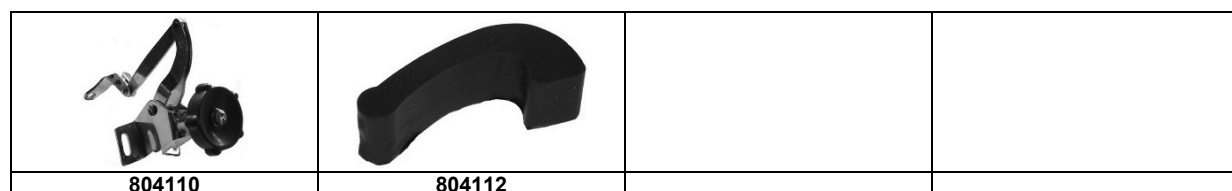
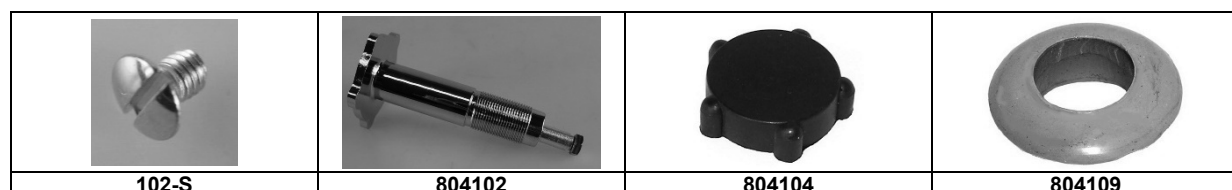
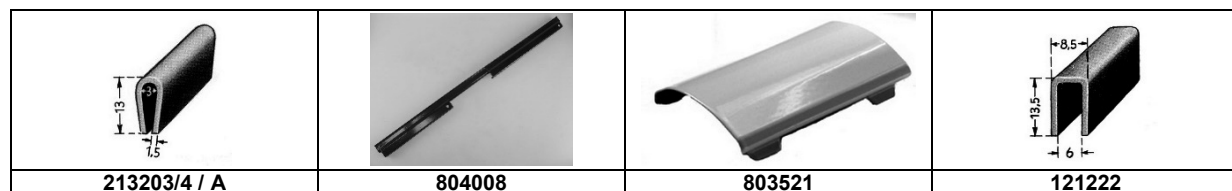
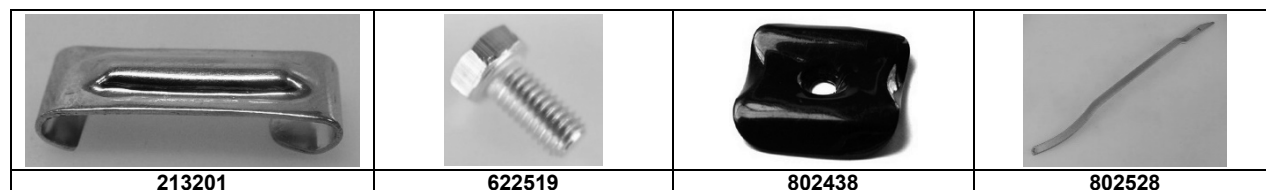
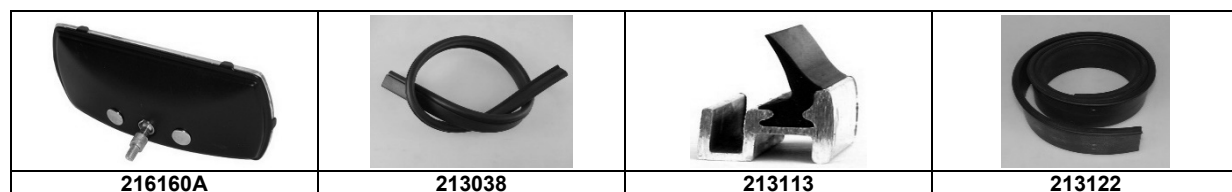

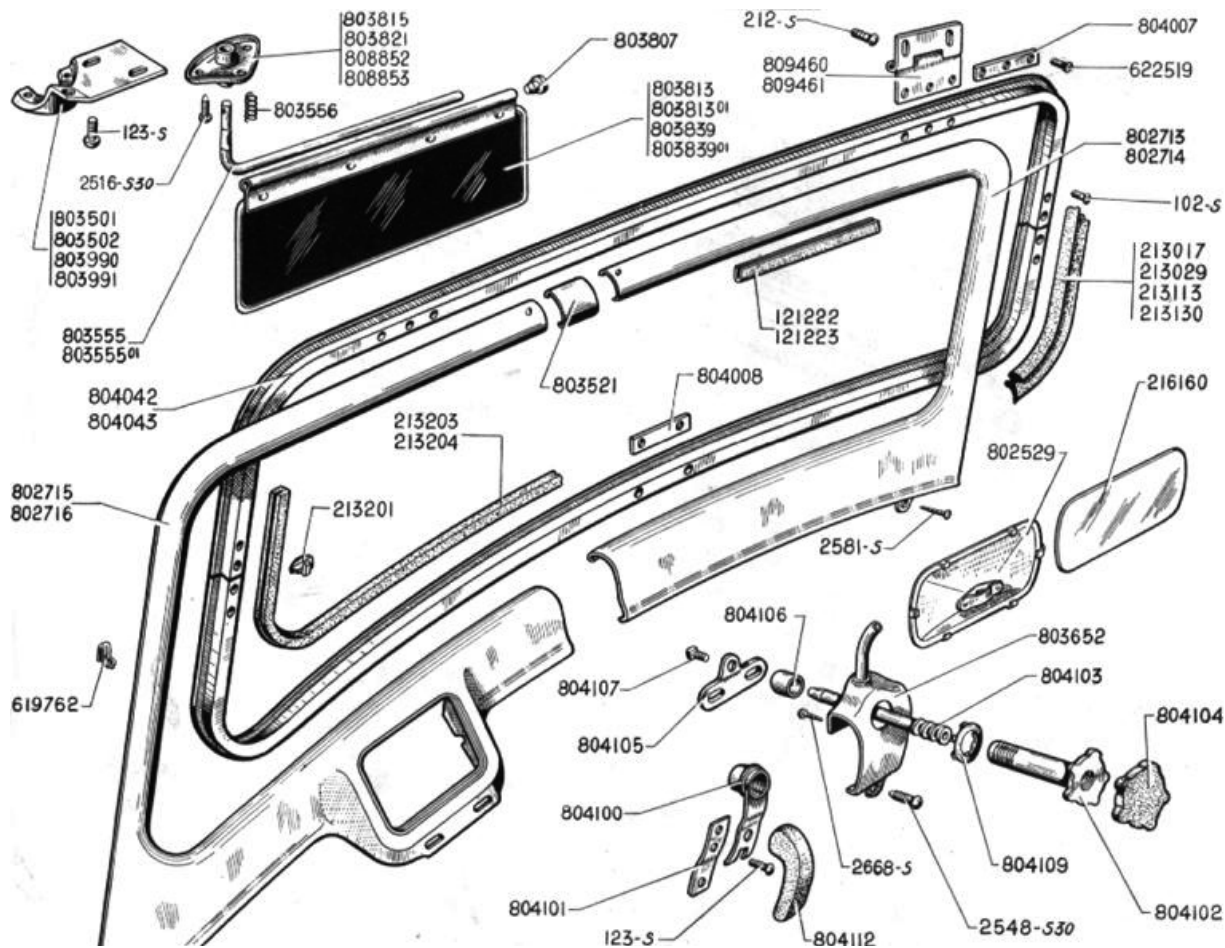

### GLACE





No d'article	article		Prix CHF
71593-L	GLACE DE PORTES AVANT GAUCHE	658mm	212.00
71593-R	GLACE DE PORTES AVANT DROITE	658mm	212.00
71594-L	GLACE DE PORTES ARRIERE GAUCHE	669mm	212.00
71594-R	GLACE DE PORTES ARRIERE DROITE	669mm	212.00
807129	GLACE DE PARE-BRISE	985x325mm	340.70
71648	GLACE DE LUNETTE AR	768x210mm	198.00
807130	GLACE DE PARE-BRISE	1140x271mm	372.00
807102	COULISSE GLACES JEU 4 PORTES	840cm	62.10







## OPTIQUE

No d'article	article		Prix CHF
706305	TEMOINS DE PHARE MARCHAL 191	2 stk/pc	14.90
706306	TEMOINS DE PHARE CIBIE 197	2 stk/pc	14.90
706307	TEMOINS DE PHARE DUCELLIER 189	2 stk/pc	14.90
706308	ENTRETOISE FIXATION DE PHARES	per Stück	5.90
706315	FEU ANTIBR MARCHAL 630 GRAND	Ø160mm	217.20
706315/9SA	SUPP FEU ANTIBROUILLARD ALU	H 70x29mm	79.60
706319	FEU ANTIBR MARCHAL 640 MINI	Ø140mm	223.90
706366BV	FIXATION COLL PROJ MARCHAL	20x26mm	10.20
706366C	PHARE MARCHAL+CERCLE 391	191 mm	147.60
706366Z	PHARE MARCHAL+CERCLE 348	210 mm	319.70
706370C	PHARE CIBIE+CERCLE 349	197mm	235.10
706302	PORTE AMPOULE FEU MARCHAL		48.20
706366	PHARE MARCHAL 177 MM		126.40
706370D	PHARE DUC		210.00
6.88022	CONNECTEUR LAMPE BILUX		5.20

			
<b>6.88022</b>	<b>706370C</b>	<b>706305</b>	<b>706306</b>

			
<b>706307</b>	<b>706308</b>	<b>706319</b>	<b>706315</b>

			
<b>706315/9SA</b>	<b>706366</b>	<b>706366BV</b>	<b>706366C / Z</b>

			
<b>706370D</b>	<b>706302</b>		

## FEUX AR INDICATEURS FEU LANTERALE

No d'article	article		Prix CHF
6.88600	Oldtimer 6 Volt LED		198.00
12472	CAOUTCHOUC CLIGNOTANT PETIT		1.90
706312	CENTRALE CLIGNO MECANIQUE HB	26/18mmØ	54.10
706313	COMMANDE INDICATEUR DIR+LEVIER	17x4,5x3cm	46.50
706314	CABOCHON FEU JOCKEY	79x37mm	41.80
706540	FEU A RRIERE CPL. VERRE	Ø95mm	96.50
706592C	FEU ARR CROUTON+CAOUTCH+SUPP G	135x80mm	45.20
706595	FEU ARRIRRE CAOUTCH	140x86mm	8.40
706611C	FEU ARR CROUTON+CAOUTCH+SUPP D	135x80mm	43.20
721119	FEU DE PARKING G+D	61x30mm	21.50
723405E	CENTR CLIGNOTANTE 6/12V ELEC	50x30x30mm	58.30
803729	FEU IND DIR AV D NOIR/BLANC	95x52mm	17.70
803730	FEU IND DIR AV ROUGE D+G	95x52mm	17.70
803808	FEU IND DIR AV G NOIR/BLANC	95x52mm	17.70
803810	FEU IND DIR ORANGE GAUCHE	95x52mm	17.70
803810R	FEU IND. DIR. ORANGE D	95x52mm	17.70
803852	JOINTS ETANCH FEUX INDICATEURS	103x60x8mm	10.20
803853	SUPPORT CLIGNOTANT	86x42mm	25.00
803879	COUVERCLE DE FEU IND. NOIR/ORANGE AR		17.70
706572	JOINT ETANCH LANTERNE MALLE AR	29x5,5cm	17.00
706601	LANTERNE IMMATRICULATION NOIRE	komplett	286.40
706600	REFLECTEUR DE FEU ARRIERE	124x45mm	21.90
706304A	CAVALIER SUPPORT REFL (NOIR)		10.80
706320	FEU SURMONTAGE BOULE ROUGE	Ø60x38mm	17.70
706320A	FEU SURMONTAGE BOULE BLANC	Ø60x38mm	16.20
706320B	FEU SURMONTAGE BOULE ORANGE	Ø60x38mm	15.00
706304	REFLECTEUR 6 CM ROUGE	Ø60x6mm	13.60

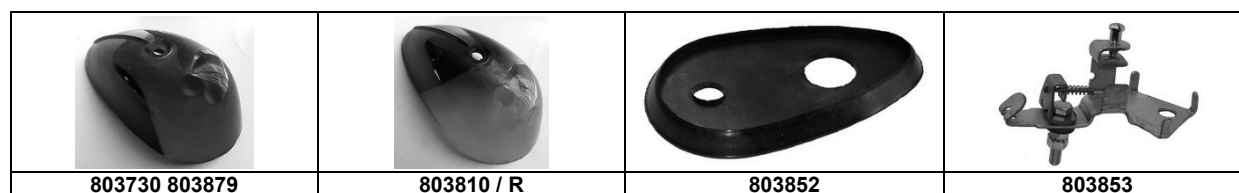
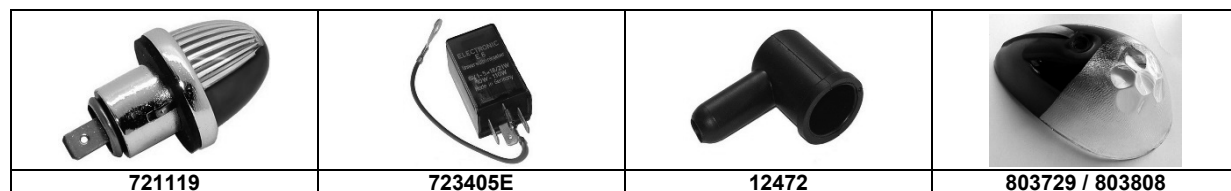
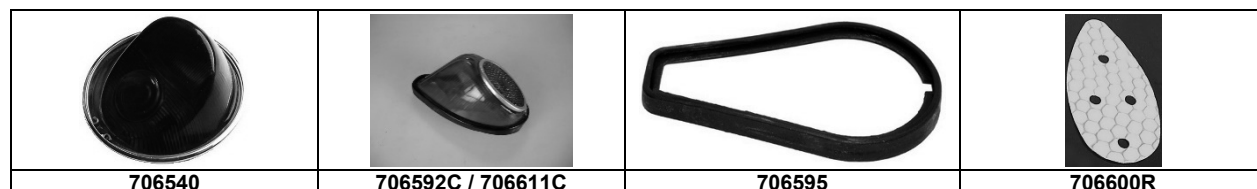
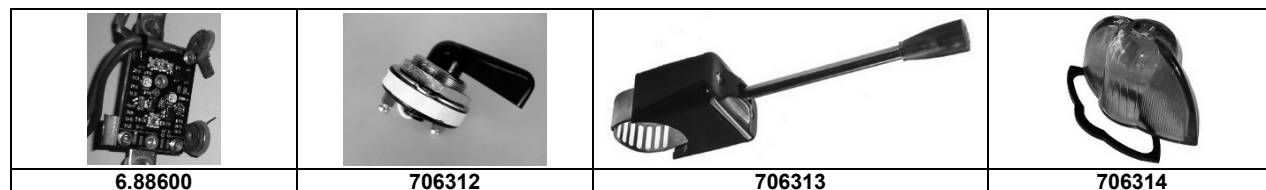

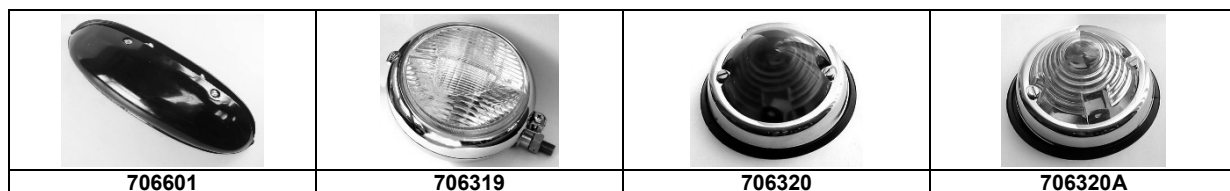

# Oldtimer 6 Volt LED

LED Brems- und Rücklicht für Veteranen mit 6Volt-Anlage  
 Universal einbaubar 30x50mm  
 2 Montage-Löcher  
 Eingangsspannung 4V-20V  
 Temperatur-Bereich -40 Grad bis + 80 Grad  
 LED-Typ für automotive Anwendung, robust  
 LED Rücklicht: 0.4W (12mal weniger)  
 LED Bremslicht: 2W (7mal weniger)  
 Industrie Standard  
 Keine Jubel-Elektronik  
 In der Schweiz hergestellt  
 Bewährte Schaltung seit 2009  
 Weiterentwicklung 2016  
 Sofort lieferbar  
 5 Jahre Garantie  
 LED leuchtet rot (weiss auf Anfrage)  
 Stabilisierte Leuchtkraft  
 Kein Flackern (hell/dunkel) bei Spannungsschwankungen



# Oldtimer 6 Volt LED

- encastrable universellement 30x50mm
- 2 trous de montage
- tension d'entrée 4V – 20V
- plage d'utilisation thermique ( -40 + 85°C)
- type de LED pour utilisation automobile, exécution robuste
- éclairage arrière LED: 0.4W (consommation réduite de 12 fois moins)
- éclairage freins : 2W (consommation réduite de 7 fois moins)
- standard industriel
- pas d'électronique gadget
- fabriqué en Suisse
- a fait ses preuves depuis 2009
- nouvelle version 2016
- livrable de suite
- 5 ans de garantie
- LED s'éclaire en rouge (en blanc sur demande)
- homologué
- puissance d'éclairage stable
- pas de vacillement lors de différence de tension
- 



Prix (paire) CHF 198.00



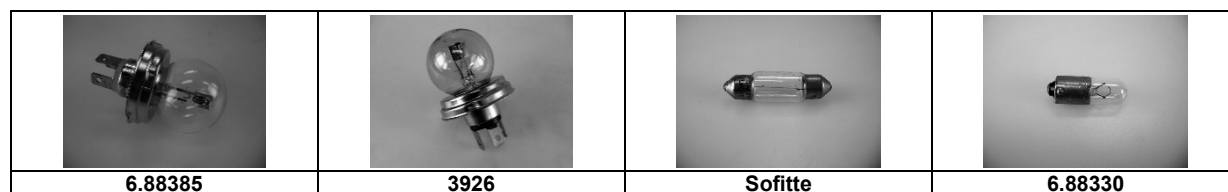
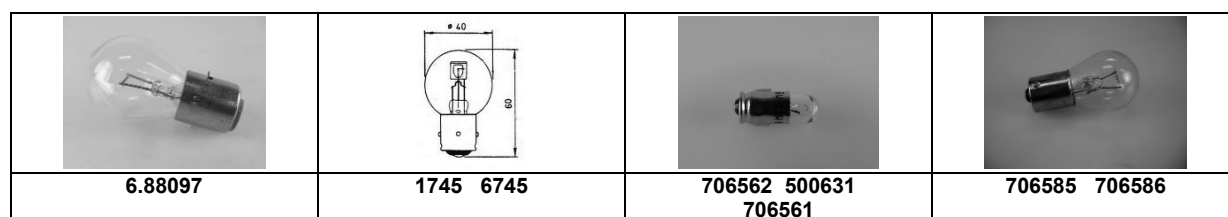
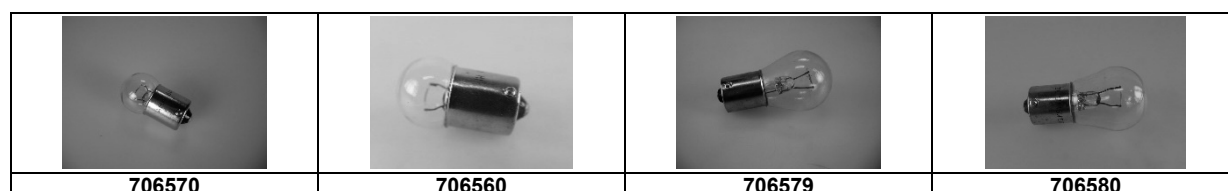

## LAMPE 6 V



No d'article	article	fabricant	Prix brut
706570	AMPOULE BALLON 6V 15W	BA15S	2.00
706560	AMPOULE BALLON 6V 10W	BA15s 15x37mm	2.00
706579	AMPOULE BALLON 6V 21W	BA15s 15x46mm	2.90
706580	AMPOULE BALLON 6V 18W IND	BA15s 15x46mm	2.00
6.88097	AMPOULE 6 V 45 W	BA20s	10.30
1745	AMPOULE 6V 45/40W JAUNE	BA21d	18.00
6745	AMPOULE 6V 45/40 bi BAJONET	BA21d	18.00
706562	AMPOULE BALLON 6V 1.2W	BA7s 7x20mm	2.00
500631	AMPOULE BALLON 6V 2W	BA9s	2.90
6432	AMPOULE 6 V 5 W BA 9 S	BA9s	2.20
706561	AMPOULE BALLON 6V 4W	BA9s 9x27mm	2.10
706585	AMPOULE BALLON 6V 18/5W	BAY15d	3.00
706586	LAMPE 6 V 21/5 W	BAY15d	2.80
6050	AMPOULE HALOGENE H1 6V 55W	P14,5s	9.80
6.88101	AMPOULE HALOGENE H3 6V 55W		18.20
6.88111	AMPOULE 6 V H4 65/55 W	P43T	33.70
6.88385	LAMPE DE PHARE	P45T	12.00
3926	AMPOULE 6V 40/45W JAUNE	P45T	14.40
6150	LAMPE H4 6 V 60/50 W	P45T	26.60
6.88209	AMPOULE 6 V 5W	SV8,5 35x10mm	1.80
706542	AMPOULE TUBE 6V 10W	SV8,5 36x11mm	2.10
707048	AMPOULE TUBE 6V 18W	SV8,5 41x15mm	2.00
707046	AMPOULE TUBE 6V 15W STOP	SV8,5 43x15mm	2.00
707049	AMPOULE TUBE 12V 18W	SV8,5 43x15mm	2.30
706546	AMPOULE TUBE 6V 10W	SV8,5 44x11mm	2.00
6.88227	AMPOULE TUBE 6 V 18 W 11x38	SV8.5 38 X 11	1.80
6.88330	AMPOULE 6 V 5 W S9 TABLEAU	BA15s	1.20
706582G	AMPOULE BALLON 6V 35W JAUNE	BA20s	10.20
706670	AMPOULE TUBE 6V 3W	S7 30x6mm	2.80
706582	AMPOULE BALLON 6V 35W	BA20s	9.80



## LAMPE 12 Volt

No d'article	article	typ	Prix brut
6.88300	LAMPE DE PHARE 40/45 W	P45T	4.20
6.88341	LAMPE DE PHARE 40/45 JAUNE	P45T	9.00
6.88359	LAMPE H4 JAUNE OSRAM	P43T	16.00
6.88360	LAMPE DE PHARE H4	P43T	9.90
6.88204	LAMPE 12 V 4 W	BA9s	0.90
6.88205	LAMPE 12 V 5 W S15	BA15s	0.90
6.88206	LAMPE 12 V 10 W	BA15s	1.60
6.88214	LAMPE 12 V 21 W	BA15s	1.50
6.88326	LAMPE 21/5 W	BAY150	1.70
6.88386	LAMPE 12 V 21/4 W	BAZ15d	3.90
6.88215	LAMPE 21 W JAUNE	BA15s	4.20
6.88320	LAMPE H1 12V 55W	P14,5s	6.30
6.88202	AMPOULE 12 V 3 W	W2 1 X 9 5 D	1.50
6.88207	AMPOULE SOFFITTE 10W	10.5 X 41	2.00
6.88208	AMPOULE SOFFITTE 5W 12V	10.5 X 41	2.00
6.88213	AMPOULE SOFFITTE 10W	10.5 x 36	2.00
6.88224	AMBOULE SOFFITTE 12 V 10 W 10.5 X 40	SV8.5 10.5 x 40	2.00
6.88225	AMBOULE SOFFITTE 12 V 10 W 10.5 X 38	SV8.5 10.5 x 38	3.90
6.88226	AMBOULE SOFFITTE 5 W 12 V 40 x 10.5	SV8.5 10.5 x 40	3.50
6.88212	AMPOULE SOFFITTE 10 W 36 x 10.50 12 V	SV8.5 10.5 x 36	3.00
6.88219	AMPOULE SOFFITTE 18 W 12 V 40 x 15.5	SV8.5 15.5 x 41	3.40
6.88203	AMPOULE 12 V 5 W	W2.1 X 9.5 D	1.20
6.88301	LAMPE 12 V 45/40 W HALOG. BILUX	P45T	12.90
1757	AMPOULE 12 V 36/36W	BAZ21D	18.40
6.88201	AMPOULE 1.2 W	W2 x 4.6D	1.20
6.88220	AMPOULE 12 V 5 W	W2 x 9 D	6.50
6.88361	AMPOULE 12 V H4 SOCLE BILUX	P45T	9.90
7389G	AMPOULE 12V 40/45W JAUNE	BA21D	16.50
6.88216	LAMPE 12 V 5 W S 9	BA9s	1.70
6.88228	AMPOULE 12V 2 W Ba7S	BA7S	1.70
706581	AMPOULE BALLON 12 V 45 W	BA 20s	6.00
6.88358	VERRE JAUNE POUR AMPOULE H4		4.70

			
<b>6.88360</b>	<b>6.88300</b>	<b>6.88341</b>	<b>6.88359</b>

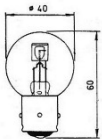
			
<b>6.88206</b>	<b>6.88326</b>	<b>Sofitte</b>	<b>7389G</b>

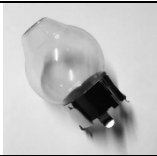
			
<b>6.88358</b>			

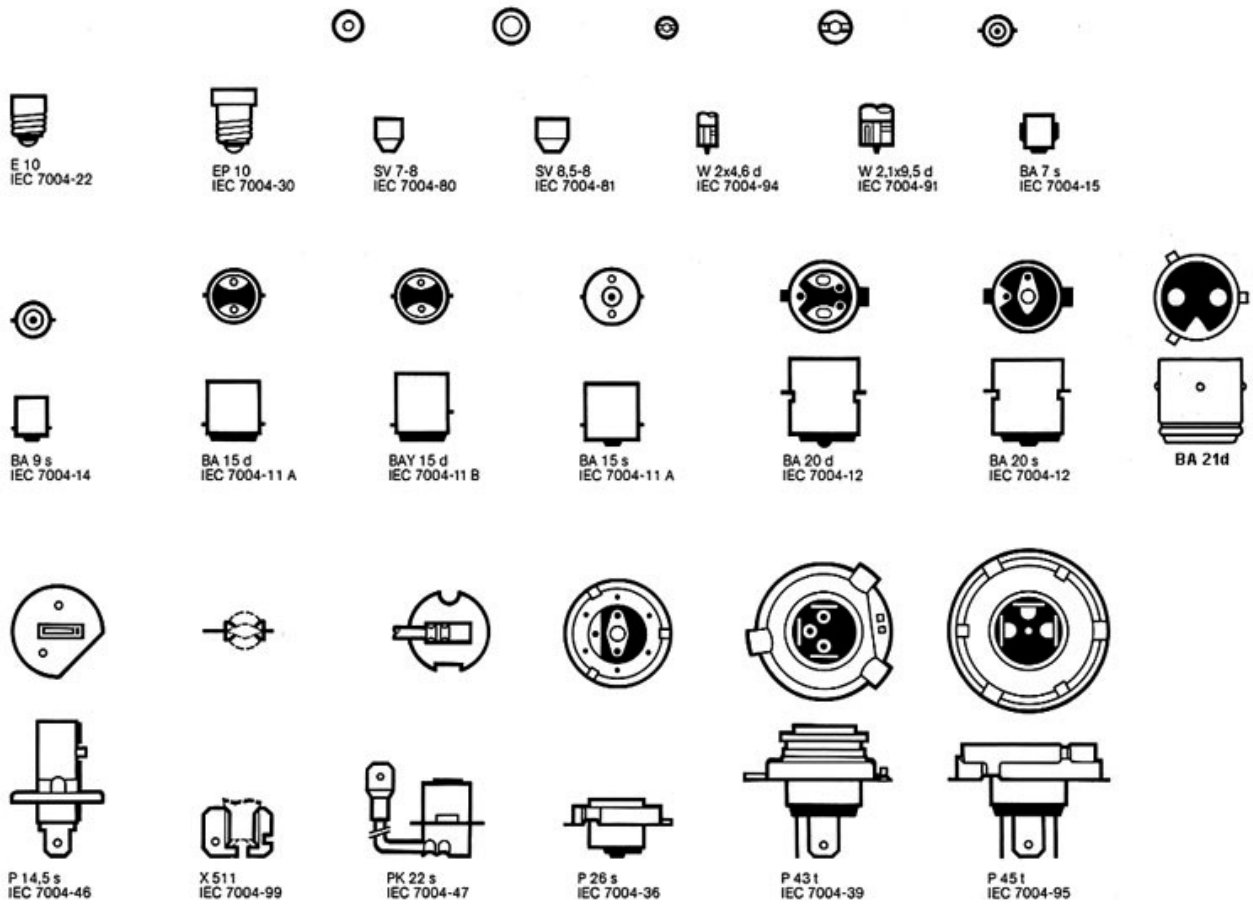

**PNEU**

No d'article	article		Prix CHF
165400	PNEU 165x400 MICHELIN X		295.00
165400B	CHAMBRE A AIR 165X400 MICHELIN		45.00
165401	MANCH RED VALVE CHAMBRE A AIR		2.10
185400B	CHAMBRE A AIR 185X400 MICHELIN		57.00
200000	FILET RAPP VIS CACHE-MOY ROUE	Ø22x18x6,5mm	6.90
298701	CALOTTE CUIVRE/CHROMEE ROUE	Ø125x30mm	26.70
299793	CACHE-MOYEU ROUE PILOTE	Ø291x70mm	40.20
299793A	ARAIGN CACHE-MOYEU ROUE PILOTE		34.00
299795	VIS CACHEMOYEU ROUE INOX	M10x28	16.60
390170	ENJO CHROME SANS TROU	Ø125x32mm	23.00
810002A	JOINT FIBRE VIS DU CACHE-MOYEU	17x22mm	0.70
810300	CACHE-MOYEU ROUE BELGE	Ø271x48mm	37.30
810300A	CACHE-MOYEU ROUE BELGE CHROME	Ø271x48mm	68.10
810315	CACHE-MOYEU ROUE BM	Ø250x45mm	57.10
810315A	CACHE-MOYEU ROUE BM CHROME	Ø250x45mm	74.30
810315R	CAOUTCHOUC CACHE-MOYEU ROUE	4x85cm	11.10
810417	VIS CACHEMOYEU BM INOX	M14x17,sw 19mm	13.00
A416-2	TOC DE ROUE 31.5MM		12.70
648424	MANIVELLE DEMARRAGE		123.90
392581	ECROU ROUE PILOTE 18 MM LONG	M12x125	10.10
392581A	ECROU FIXAT DE ROUE BELGE	M12x125	16.90
6.90841	ECROU DE ROUE	M12x125	5.00
299793C	CACHE MOYEU ROUE PILOTE CHROME		70.20

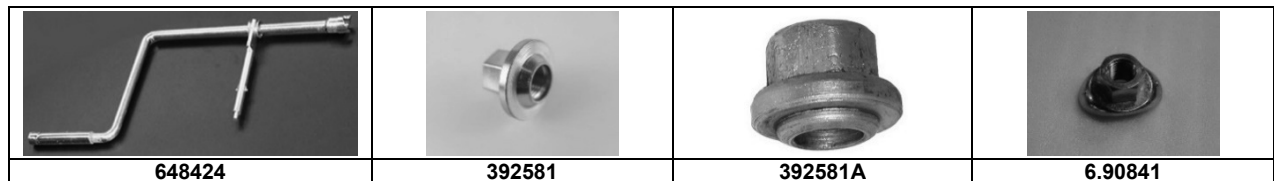
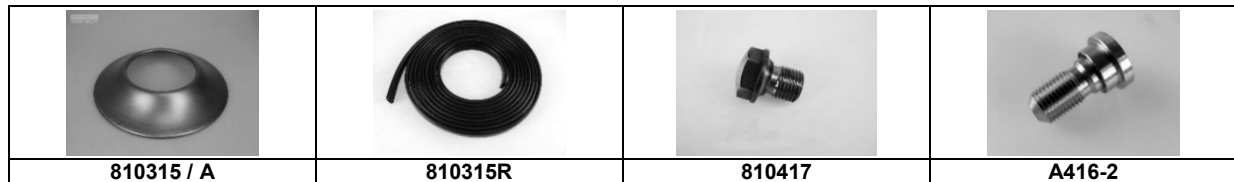
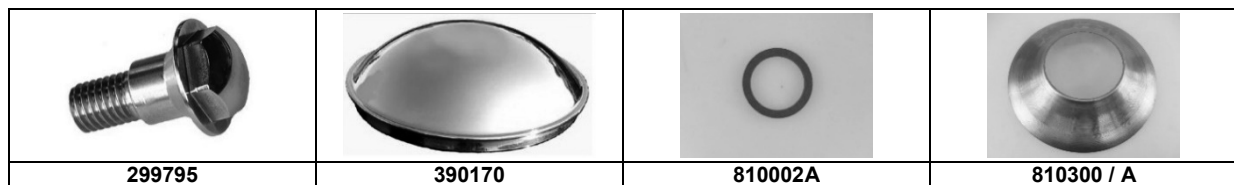
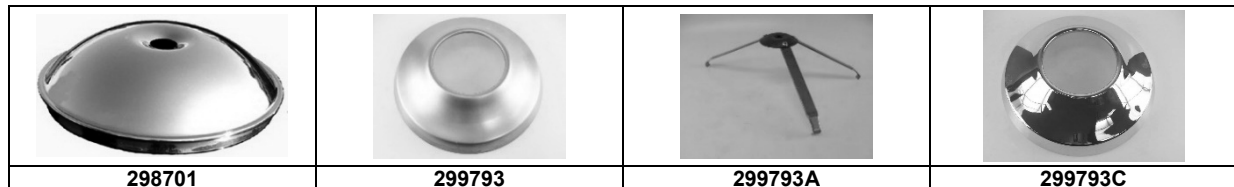

## SIEGES

No d'article	article		Prix CHF
150479	AXE ARTIC DOSS STRAPONTIN INOX		15.70
224415	ROULETTE DE SIEGE FER	Ø26x27mm	11.00
232792	AXE DE GALETS CAOUTCHOUC SUP.	6x32mm	2.30
232793	FIXATION DOUILLE SUPP SIEGE	39x20mm	7.80
232888	RONDELLE POIGNEE DE COMMANDE	Ø40x31x1,6mm	4.30
232888A	RONDELLE POIGNEE DE COMMANDE	Ø10x6x5mm	1.20
233163	ROULETTE DE SIEGE CAOUTCHOUC	Ø22x27,5mm	5.00
6.99027	RONDELLE FIXATION SIEGE AVANT	7,5x16	0.30
298748	TUBES DE GALETS AR	Ø9x28mm	4.20
319-S30	VIS FIXATION SIEGE	M6x55	1.60
407-S	VIS FIXATION SIEGE	M6x50	1.20
485-S30	VIS SUPPORT SIEGE AVANT	M7x20	0.30
802483	RESSORT DE RAPPEL POIGNEE	140 mm.	7.40
802486	FIXATION SIEGE AVANT DROIT	p.st.	24.40
232793S	ARRETOIR FIXATION SIEGES COMPL.		11.90

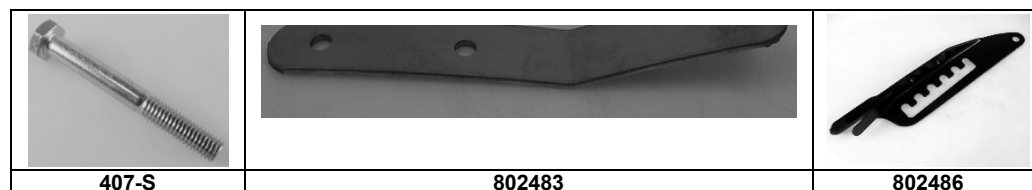
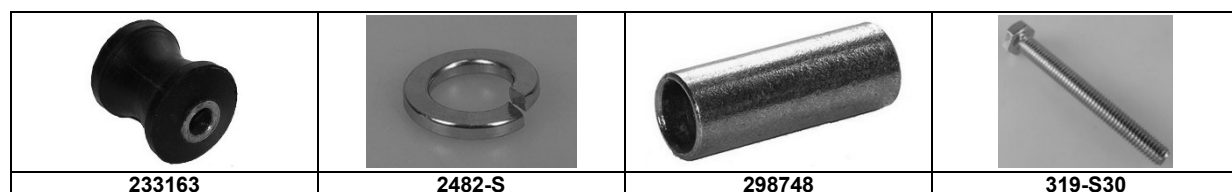
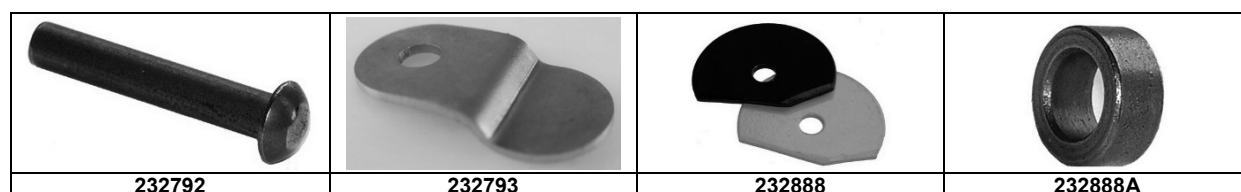
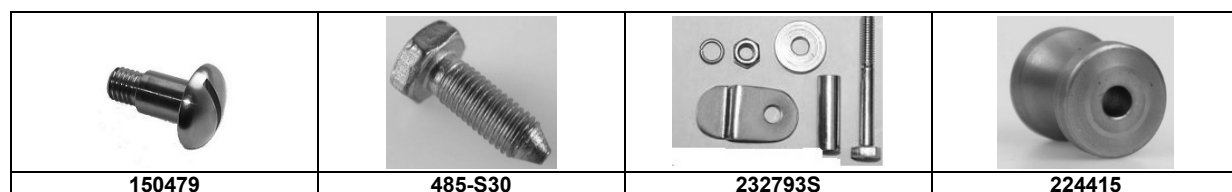

## INTERIEUR TISSUS

No d'article	article		Prix CHF
100002	GARNITURE DU TOIT GRIS CLAIR	150cm br	109.00
100003	GARNITURE DU TOIT BEIGE	150cm br	109.00
100010A	CUIR ARTIFICIEL TA	140cm br	46.00
100012	JEU FEUTRE IS. 10MM GROS EPAIS	7m <sup>2</sup>	206.60
100015	TISSU RAYE GRIS	156cm br	162.90
100015A	TISSU RAYE GRIS	142cm br	124.80
100017D	KIT ENVELOPPE SIEGES + PORTES	14 pc/stk	1990.00
100017E	KIT ENVELOPPE SIEGES + PORTES	12 pc/stk	1730.00
100021	ENCADREMENT VITRE ARRIERE BOIS	84x28,5cm	53.80
100024	GARNITURE MONTANT PORTE INT	97,5x21cm	23.90
100025	PANNEAU GARNITURE PASSAGE ROUE	56,5x13,5cm	15.90
100026	BANDE ASSE CIEL TOIT COTON AR	100,5x6,5cm	10.70
100029	OREILLE SIEGE ARR. +CLIP	Set, L+R	67.00
100030	OREILLE SIEGE ARR. +CLIP	Set, L+R	70.90
100031	ENS (CONTREPLAQUE) REMPLISSAGE	73x9cm	52.40
100033	PANNEAU LATERAL DU TOIT	84x39cm	31.90
100034	PANNEAU LATERAL DU TOIT	99X56cm	22.60
121178	CORDE FIX BAND PORTE INT/CARR	8,5mtr	25.10
216053	PATTE SUP ARTIC PARE-SOLEIL	26,5x15,5xmm	10.00
229247	KIT COMPLET DE MOQUETTE GRIS		654.80
229260N	KIT COMPL MOQUETTE-COFFRE GRIS		161.50
229260V	KIT COMPL MOQUETTE-COFFRE GRIS		168.80

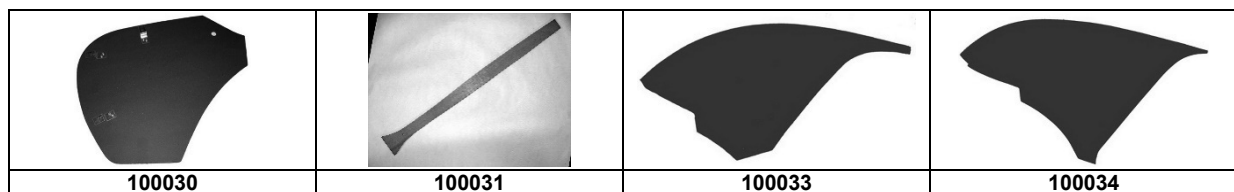
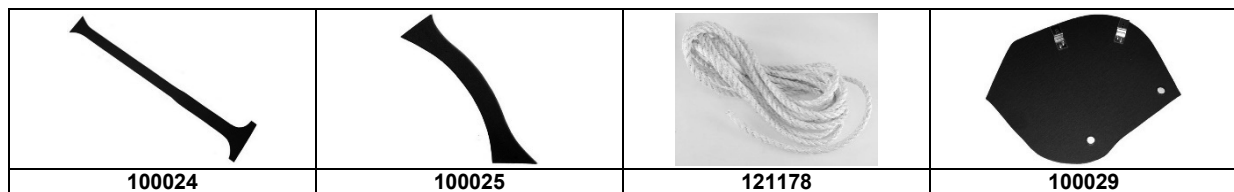
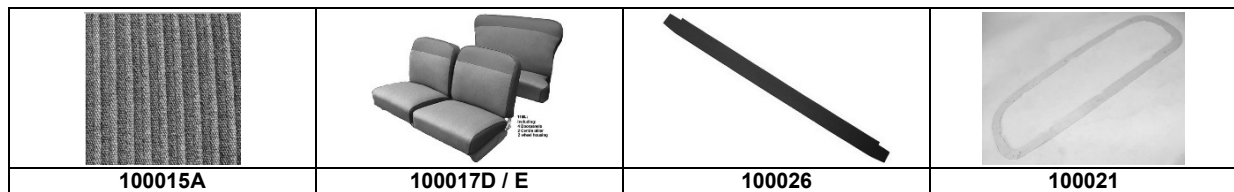
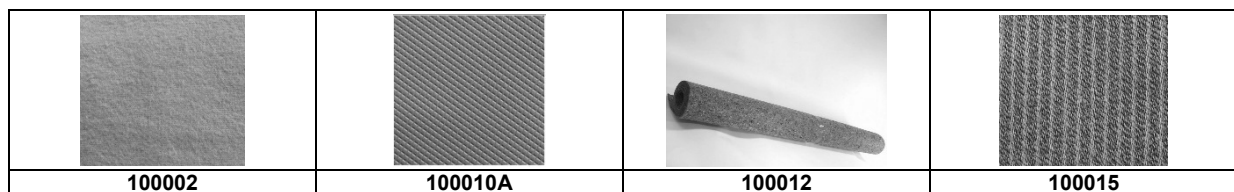

## INTERIEUR TISSUS

No d'article	article		Prix CHF
229273	KIT COMPLET DE MOQUETTE GRIS		687.20
229273N	KIT COMPL. MOQUETTE-COFFRE GRIS		163.70
229273V	KIT COMPL. MOQUETTE-COFFRE GRIS		154.50
229927	BANDEAU PORTE INTERIEUR BEIGE	10mtr	133.10
232873	FEUILLARD AR MILIEU		56.20
232874	FEUILLARD AR DROIT		56.20
232875	FEUILLARD AR DROIT		56.20
6.54801	AGRAFE PANNEAU DE PORTE	20mm	1.00
62306	POINTE VRILLEE POUR MOQ 23X2MM	1 stk/pc	0.20
802658	ENSEMBLE PILASTRE INF. (TOLE)		68.20
802661C	PLA.Q. CARTON PORTE PORTES	4x52,5(x8,5)cm	47.80
803642	FEUILLARD LAT AV PAVILLON D		33.80
803643	FEUILLARD LAT MILIEU PAVILON G		56.70
803644	FEUILLARD LAT MILIEU PAVILON D		56.70
803645	FEUILLARD LAT AR PAVILLON D+G		50.00
803646	FEUILLARDTOIT AR G/D INOX		47.30
804048	JEU BAS DE MARCHE DE PORTES	4 stk/pc	51.30
804050	JEU BAS DE MARCHE DE PORTES	4 stk/pc	50.70
804426	KIT COMPLET DE MOQUETTE GRIS	set	920.00
808001	CARTON DE PORTES POLYST AR G/D	72x51,5cm	33.80
808004	CARTON DE PORTES AR G/D	77,5x51,5cm	43.20

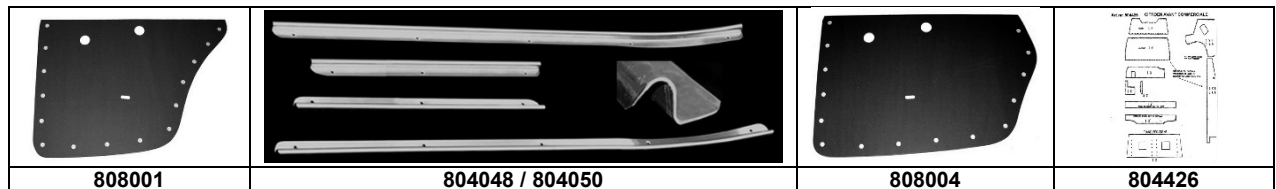
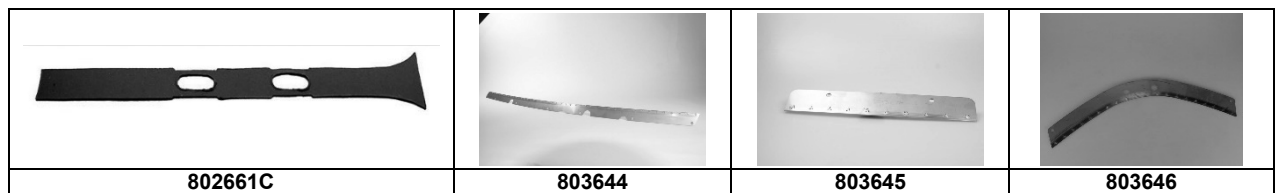
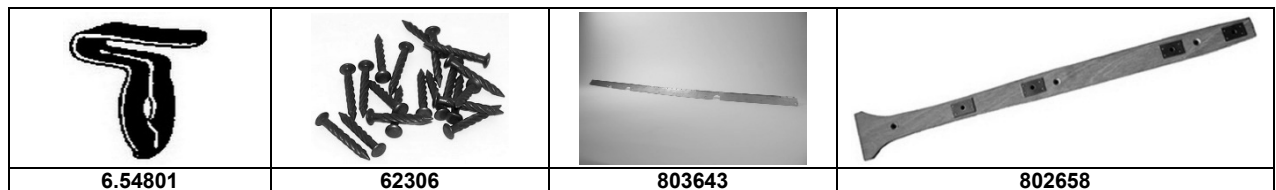

## INTERIEUR TISSUS

No d'article	article		Prix CHF
808010	CARTON POLYST DE PORTES AV G/D	84,5x51,5cm	32.40
808308	CIEL DE TOIT COTON GRIS	set	674.00
808308V	CIEL DE TOIT COTON GRIS	set	674.00
808308VB	CIEL DE TOIT COTON BEIGE AV	set	700.00
808335	CIEL DE TOIT COTON GRIS	set	687.00
808335B	CIEL DE TOIT COTON BEIGE AV	set	700.00
808335V	CIEL DE TOIT COTON GRIS	set	674.00
808335VB	CIEL DE TOIT COTON BEIGE AV	set	700.00
808337	FEUILLARD AR MILIEU		36.40
808340	FEUILLARD AR DROIT		36.90
808341	FEUILLARD AR DROIT		36.90
808941	BANDEAU PORTE INT GRIS 19MM	10mtr	160.20
808991	KIT COMPLET DE MOQUETTE GRIS	set	987.00
809294	CARTON POLYST DE PORTES AV G/D		33.80
809299	CARTON DE PORTES AR G/D 11BN <7/52	77,5x59cm	33.80
809300	PANN.PORTE BOARD AR G/D 11BL <7/52	72,5x60cm	33.80
809466/7	BAVETTE CAOUTCHOUC BAS PORTES	53,5+2x87cm	22.90
809466/8	BAVETTE CAOUTCHOUC BAS PORTES	70,5+2x87cm	26.70
809527	CARCASSE MATELASSE DE COUSSIN	121x49cm	601.00
809527L	CARCASSE MATELASSE COUSSIN AV	51x50,5cm	158.30
809527RL	CARCASSE MATELASSE DERRIERE AV	504x480x110mm	158.30
809529	PAQUET RESSORTS SIEGE ARR	131x47cm	489.00
809529B	CARCASSE MATELASSE COUSSIN AV	56x50,5cm	169.10

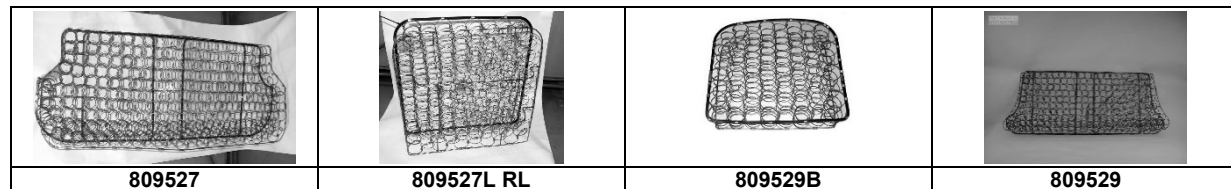
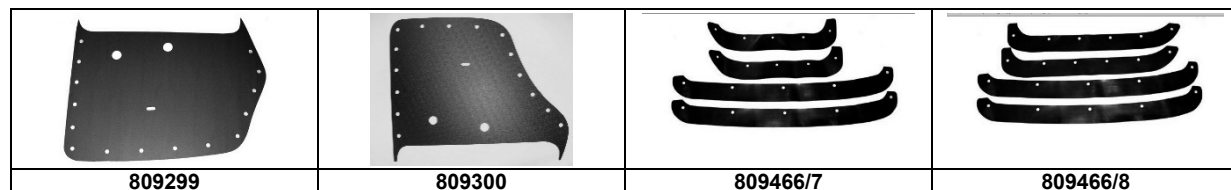
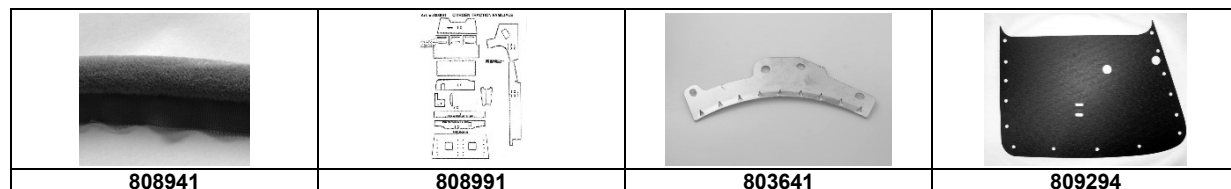
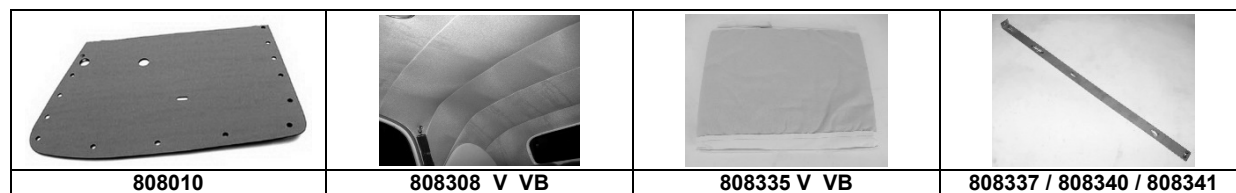

## INTERIEUR TISSUS

No d'article	article		Prix CHF
809529RH	CADRE SIEGE A RRIERE VERT		162.30
100020	CARTON MOULURE GLACE AV. D+G		52.00
802661	MONTANTPORTE PANN.BOIS B	73x9cm+Platte	68.10
803641	FEUILLARD DE TOIT AV G INOX		33.80
808684	CARTON DE TOIT GAUCHE +CLIPS		29.70
2582-S	PARKER ENCADR LUNETTE/CUSTODES		0.10

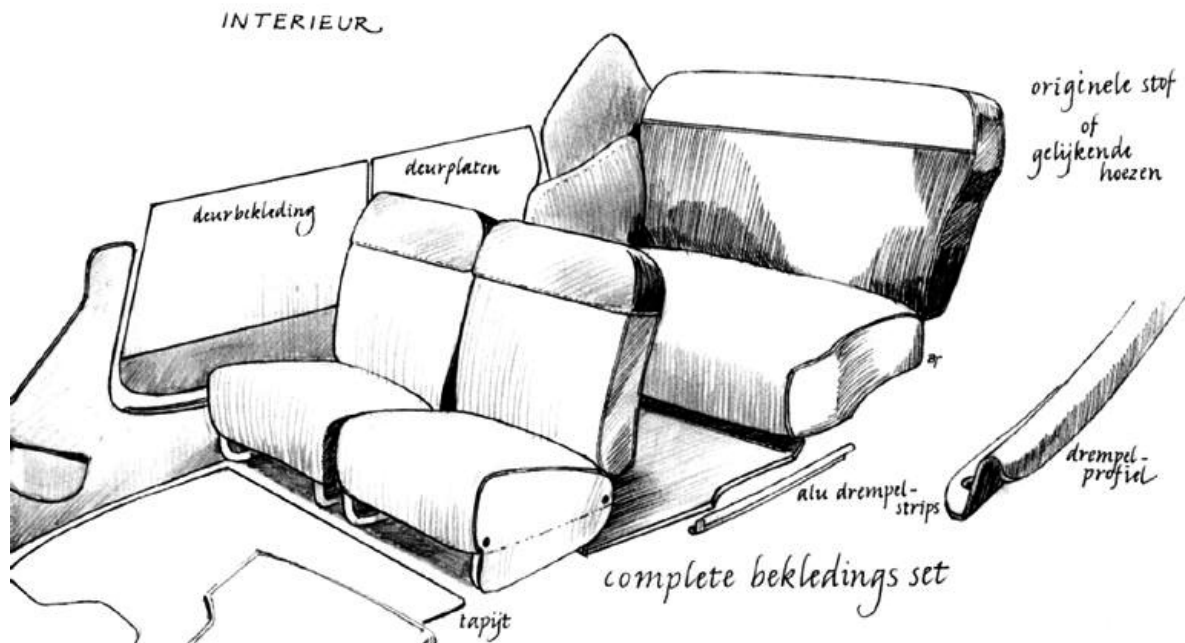

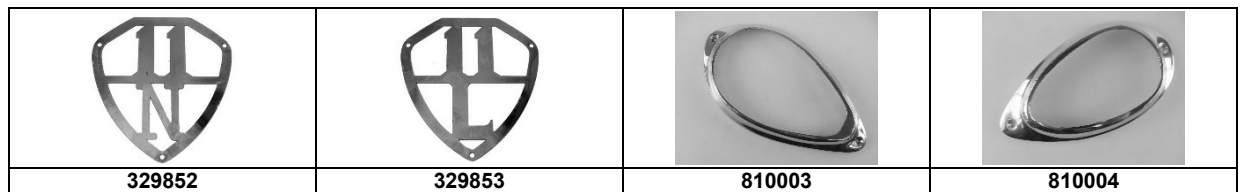
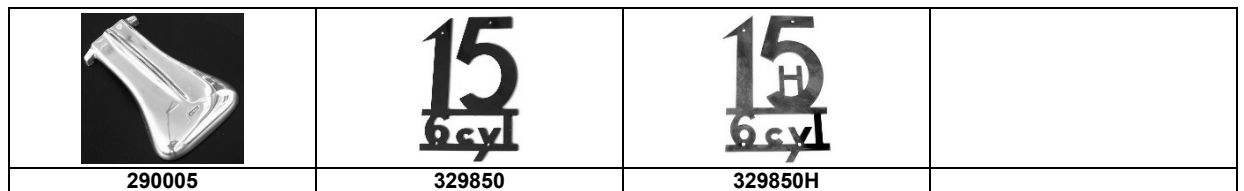
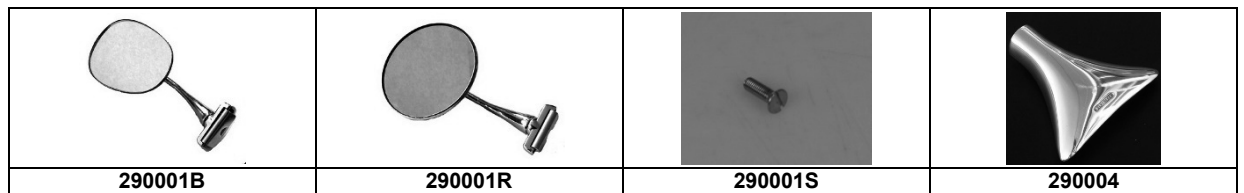
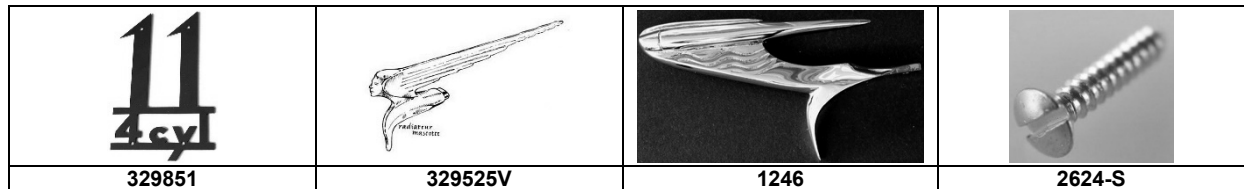

## ACCESSOIRES CHROME

No d'article	article		Prix CHF
1246	MOTIF SUR CALANDRE BOLIDE	200x100mm	96.90
2624-S	VIS FIXAT SABOT AILE ROBRI JEU	1 stk/pc	0.30
290001B	RETROVISEUR EXT.A Pincer OVALE	122x87,5mm	82.40
290001R	RETROVISEUR EXT.A Pincer ROND	O114mm	66.20
290001S	JEU VIS RETR EXT.A Pincer INOX	M5x16, 4 stk/pc	0.80
290004	ROBRI ENJOLIVEUR ECHAPPEMENT	315 180x175mm	94.50
290005	ROBRI ENJOLIVEUR ECHAPPEMENT	316 260x175mm	99.20
329525V	MOTIF SUR CALANDRE TETE	-	139.70
329850	EMBLEME AILE ARRIERE INOX	83x138mm	27.10
329850H	EMBLEME AILE ARRIERE INOX	83x138mm	32.80
329851	EMBLEME AILE ARRIERE INOX	83x138mm	27.10
329852	EMBLEME AILE ARRIERE INOX	100x107mm	26.80
329853	EMBLEME AILE ARRIERE INOX	100x107mm	27.10
810003	ROBRI FEU ARRIERE ALU		37.50
810004	ROBRI CLIGNOTEUR OVALE ALU		28.50
810004L	ROBRI ENJOLIVEURS CLIGNOT AV		57.50
810005	ROBRI ENTOUR ECLAIRAGE PLAQUE	226 325mm	62.50
810006CH	ROBRI CH PLAQ NATIONAL GRAND CH		36.00



## ACCESSOIRES CHROME

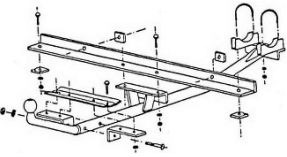

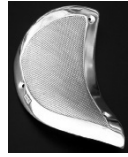
No d'article	article	Prix CHF
329525B	MOTIF SUR HAUT CALANDRE 11 B	139.70
160000	CROCHET A TTELAG E 52 -	735.00
6.90700	PLAQUETTE TYPE/SERIE	9.80
6.80088	Robri enjoliveurs clignoteurs AV ( le pa	81.10
6.90644	SIGLE CITROEN POLICE CURSIVE INOX	27.30
320001	PLAQUE CITROEN INOX	18.50
810352	SABOT AILE AXO AV G	50.00
329525B	MOTIF SUR HAUT CALANDRE 11 B	139.70





			
160000	6.90700	6.80088	810351 810352





			
6.90644	320001		

## OUTILLAGE





No d'article	article	CHF
1820-T	ARRACHE TAMBOUR ET ROULEMENT	182.30
1825-T	ARRACHE DE ROULEMENT AV DU TAMBOUR	65.90
1850-T	CLE POUR ECRU DE SERA GE DE ROULEMENT	89.50
1851-T	ARRACHE ROTULE INFERIEURE	122.90
1852-T	CLE DE REGLAGE POUR ROTULE SUP	90.20
2100-T	APPAREIL POUR CENTR FREINS AV	110.30
1964-T	ARRACHE ROTULE DIRECTION	62.10
2103-T	APPAREL POUR CENTRER LES FREINS AR	120.00
2911	CLE REGLAGE SOUPAPES	55.40
6.98004	GARNITURE COLLIERS DE SERRAGE UNIVER.	83.00
6.98001	PINVES LIGAREX	55.00

		
1820-T	1825-T	1850-T

			
1852-T	2100-T	1851-T	2109-T

			
2100-T	2911	6.98004	6.98001

OUTILLAGE			
No d'article	article		CHF
6.34215	CLIPSBANDESERRAGE PAR 100		20.40
6.34210	BANDE DE SERRAGE 25 M/ROULEAU		21.00
6.99706	Coffret de douilles 1/4" + 3/8" + 1/2"		199.00
6.99710	CHARGEUR DE BATTERIE 6 + 12 VOLT		78.00

			
6.34215	6.34210	6.99706	6.99710

SIEGES			
No d'article	article		Prix CHF
6.20706	TUBE FREINS 3.5 MM 25 M.		187.20
6.20710	TUBE FREINS 4.5 MM 5 M.		11.20
6.20730	ECROUS DE TUBE 3.5 MM		1.30
6.20735	ECROUS DE TUBE 4.5 MM		2.90
6.44091	VIS/ECROU ALTERNATEUR 2CV		15.80
6.54040	VIS M7 X 80 MM		2.40
6.54060	ECROU DE CHASSIS		0.70
6.54041	BOUCHON DE PLANCHER DM44MM		4.10
6.54042	BOUCHON		4.50
6.54043	BOUCHON		0.50
6.54054	ECROU AILE AR		0.40
6.54057	SILENT BLOC INTER. AILE AV		6.50
6.54059	VIS AILE AR 5 MM INOX		0.50
6.54061	ECROU AILE AVANT 2CV		5.30
6.54062	RIVET CAPOT		0.70
6.99061	RIVETS BAVETTE		0.60
6.54063	VIS FIXATION INTER.AILE		0.90
6.54101	COLLIER 70 - 90 MM		2.40
6.54102	COLLIER 50 - 70 MM		2.10
6.54103	COLLIER 40 - 60 MM		2.00
585770	COLLIER SERR FLEX ESSENCE 8MM		3.40
6.54109	COLLIER 8 - 16 MM		1.60
6.54104	COLLIER 11 - 13 MM		1.40
6.90654	ECROUS DE BOUTON 3.9 X 16 INOX		0.35
6.91402	HUILE 1 Lt 20 W 50		11.00
6.91408	HUILE 5 LT 20 W 50		40.00
6.91410	HUILE MOTEUR 15W-40 1L		11.00
6.91403	LIQUIDE DE FREIN DOT4 0.5 LTR.		8.00
6.91409	LIQUIDES DE FRAIN DOT4 0.25 LT		6.90
6.91404	LIQUIDES DE FRAIN DOT4 1.0 LT		14.00
6.91405	LIQUIDES DE FRAIN DOT4 4.0 LT		49.00
6.91401	LHM 1 LITRE		12.00
6.91406	LIQUIDE LHM VERT 5 L		45.00
6.99009	PA TE ZYLINDER FREINS 180 gr		25.20
6.99115	PA TE DE MONTAGE D ECHAPPEMENT		19.40
6.99010	ECROUS 7 MM		0.20
6.99011	ECRAUS M 8 x 1		0.40
6.99030	ECROU M 7 CUIVRE COLLECTEUR ECHAPPEMENT		1.30
6.54039	ECROU A SOUDER M7		0.80
6.99012	vise M 7 x 20		0.40
6.99013	VIS 7X25 jaune		0.40

SIEGES			
No d'article	article		Prix CHF
6.99014	VIS M 7X40 jaune		0.70
6.99016	VIS 7X16		0.50
6.99017	VIS M 7 x 30		0.50
6.99018	VIS M 7 x 35		0.50
6.99043	VIS M7 x 50		1.10
6.99020	RONDELLE m 7		0.30
6.99021	RONDELLES 5X12 jaune		0.20
6.99022	RONDELLES 5X16 jaune		0.30
6.99024	RONDELLES 7X18 jaune		0.35
6.99025	RONDELLES 7X14 jaune		0.30
6.99028	ECROU AUTOSERRANT M7		0.90
6.99036	VIS M9 x 105 ALTERNATUER		6.50
6.99031	VIS PLAQUE AMORTISEUR M9 X 16		2.90
6.99026	ECROUS M 3, VOLET AIR		0.20
6.99027	BAQUE ELASTIQUE M7		0.25
6.99050	GARNITURE 1/2 ROULEAU		30.50
6.99052	FIXATION CHASSIS		65.00
6.99060	RIVET BAVETTE		0.60
6.99053	ANTIROUILLE VALVOLINE 1LT		21.50
6.54203	ECROUS 9 MM		1.80
6.54123	BOULON M9 X 30		3.90
6.99038	RONDELLE M9		1.00
6.99039	RONDELLE A RESSORT		1.10
6.54067	VOORSPATBORDMOER		5.20
6.54073	WISE AILE AR M5x20 INOX		0.50
6.54116	ECROU M 12 EN A CIER INOX		3.00
6.54117	VIS DE FIXATION INOX		1.50
6.54118	CLIP DE BEQUILLE DE COFFRE		0.90
6.54201	CLIP DE VERROUILLAGE TIGE DE VOLET AERAT		1.40
6.99033	ECROU M4		0.30
6.99063	GRAISSEUR M6 90'		3.30
6.99064	GRAISSEUR M6 45'		3.30
6.99065	GRAISSEUR M8 45'		3.30
6.99066	GRAISSEUR M7 90'		3.30
6.99067	GRAISSEUR M6 90'		3.30
6.99068	GRAISSEUR M8 90'		3.30
6.99070	GRAISSEUR M7 45'		3.30
6.99071	GRAISSEUR M7 180'		3.30
6.99072	GRAISSEUR M6 180'		3.30
6.99815	JEU ELECTRICITE DE VOITURE		15.00
6.99200	TUYAU ESSENCE SPEZ		9.80
6.54119	BOULON COUVERCLE DE BOITE VITESSE M7		4.10
6.99040	COUVETTE TABLEAU BORD		0.40
6.99041	VIS TABLEAU BORD M5 X 20 INOX		0.60
6.99042	VIS DE TOLE TABLEAU BORD INOX		0.40
6.99037	ECROU AUTOBLOQUANT PANNEAU TAB. BORD		3.90



## **Allgemeine Geschäftsbedingungen**

### **1. Geltungsbereich**

**1.1** Diese allgemeinen Verkaufs- und Lieferbedingungen gelten und regeln den Geschäftsverkehr zwischen Ihnen, unserem Kunden (in weiteren Abschnitten als Besteller betitelt), und uns, der ETS Ersatzteilservice AG (in weiteren Abschnitten als Lieferant betitelt).

**1.2** Abweichende Abmachungen werden nur anerkannt, wenn diese in Schriftform (Brief, FAX, E-Mail) vereinbart wurden und wir diese ausdrücklich anerkennen.

### **2. Bestellungen – Lieferung**

**2.1** Bestellungen über unseren elektronischen Shop sind für den Besteller verbindlich. Der Lieferant behält sich das Recht vor, innert einer Woche vom Vertrag zurück zu treten, ohne Nennung von Gründen, und die Lieferung nicht auszuführen.

**2.2** Die vom Besteller auszufüllenden Angaben zu seiner Person / Unternehmung sind vollständig und korrekt anzugeben.

**2.3** Der Lieferant behält sich das Recht vor, diese in Zusammenarbeit mit andern Firmen zu überprüfen.

**2.4** Die Lieferung erfolgt gemäss den Angaben des Kunden. Ist dies nicht möglich (Gewicht, grösse des Pakets) wählt der Lieferant eine für den Kunden kostengünstige versandweise.

**2.5** Die im Shop angegeben Frachtkosten sind nicht verbindlich und gelten nur als Richtgrösse.

**2.6** Transportiert wird auf Rechnung und Gefahr des Kunden.

**2.7** Retouren, welche nicht auf eine Verfehlung des Lieferanten zurückzuführen sind und dem Zustand der Zustellung entsprechen, werden unter Abzug von CHF 25.00 pro Rechnungs-Linie der retournierten Ware dem Besteller gutgeschrieben.

### **3. Preise**

**3.1** Alle Preise verstehen sich in Schweizer Franken, ohne Verpackungs- und Versandkosten. EURO Preise sind nur Richtpreise, Verrechnung in EURO ist nur nach Absprach möglich.

**3.2** Die Bruttopreise verstehen sich inkl. Mehrwertsteuer.

Nettopreise oder Preise auf die ein Rabatt gewährt wird, sind exkl. MWST.

**3.3** Wir behalten uns das Recht vor, bei Preisänderungen unserer Lieferanten oder Änderungen des Wechselkurses oder allfälligen Steuern vom Vertrag zurückzutreten.

**3.4** Auf Mahnungen der Stufe 1 und 2 werden Mahngebühren von CHF 20.00 beim Besteller fällig. Aber der 3. Mahnung werden Mahngebühren von CHF 40.00 fällig. Betriebskosten sowie ein Zins von 5% werden vollumfänglich dem Besteller weiterverrechnet.

### **4. Abnahme**

**4.1** Die Ware ist nach Erhalt sofort auf Menge und Richtigkeit der bestellten Produkte zu prüfen. Abweichungen zur Bestellung sind spätestens innert 10 Tagen nach Versand zu melden.

**4.2** Ist die Ware mangelhaft oder fehlen ihr zugesicherte Eigenschaften, so haben wir die Wahl zur Nachbesserung oder Ersatzlieferung. Ist eine Nachbesserung oder Ersatzlieferung nicht möglich, finden die gesetzlichen Bestimmungen über die „Wandelung oder Minderung“ Anwendung. Der Ersatz von weiteren Schäden (Art. 208 Abs. 3 OR) wird ausgeschlossen.

**4.3** Bei Verkauf von gebrauchter Ware wird die Gewährleistung gänzlich ausgeschlossen.

**4.4** Bei pfandpflichtiger Ware wird die Rückvergütung des Pfands nur vorgenommen, wenn die entsprechende Ware in aufbereitablem Zustand den Lieferanten erreicht.

### **5. Gewährleistung / Garantie**

**5.1** Als Handelsunternehmen gewährleisten wir die Mängelfreiheit und die fehlerfreie Funktionsweise der gelieferten Ware im Ausmass der Lieferantengarantien.

**5.2** Der Garantiefumfang richtet sich nach den Garantieb Bestimmungen unserer Lieferanten und umfasst nur den Ersatz oder Vergütung der defekten Teile. Weitergehende Ansprüche (Arbeit, Versandkosten, etc.) sind ausdrücklich ausgeschlossen (siehe 4.2.).

### **6. Erfüllungsort, anwendbares Recht und Gerichtsstand**

**6.1** Erfüllungsort ist der Geschäftssitz des Lieferanten. Das Rechtsverhältnis untersteht schweizerischem Recht. Der Gerichtsstand ist das zuständige Gericht am Sitz der ETS Ersatzteilservice AG.

## Conditions générales de vente

### 1. Domaine d'application

1.1 Ces conditions générales de vente et de livraison s'appliquent et règlent les transactions commerciales entre vous, ci-après nommé client, et nous, l'entreprise ETS Ersatzteilservice AG, ci-après nommée fournisseur.

1.2 Des conditions de vente différentes du client ne sont acceptées que si elles ont été faites sous forme écrite (lettre, fax, e-mail) et reconnues par nous.

### 2. Commandes, livraisons

2.1 Une commande passée électroniquement sur notre site est un engagement contractuel. Le fournisseur se réserve le droit, dans un délai d'une semaine, de refuser la commande et de ne pas livrer le matériel sans fournir d'explication.

2.2 Les données personnelles fournies par le client/entreprise doivent être complètes et exactes.

2.3 Le fournisseur se réserve le droit de contrôler ces données en collaboration avec d'autres fournisseurs.

2.4 La livraison est faite selon les indications du client. Si cela s'avère impossible (dimensions, poids du paquet), le fournisseur choisira le mode d'envoi le plus adapté et le plus avantageux pour le client.

2.5 Les frais d'envoi indiqués sur notre site (Shop) ne sont donnés qu'à titre indicatif et n'engagent pas le fournisseur.

2.6 Les transports sont à la charge du client et sous sa responsabilité.

2.7 Les retours de marchandises qui ne sont pas dû à une erreur du fournisseur et qui reviennent dans le même état que lors de l'envoi initial seront crédités, sous déduction de 25.-fr par ligne de facture.

### 3. Prix

3.1 Tout nos prix sont en francs suisses, sans emballage ni frais d'envoi. Les prix en euros sont uniquement des prix indicatifs. Une facture en Euros peut être faite après entente.

3.2 Les prix bruts s'entendent TVA comprise.

Les prix nets ou les prix incluant un rabais sont TVA **non** comprise

3.3 Nous nous réservons le droit, lors de changements de prix de nos fournisseurs, de modification du cours du change ou de taxes supplémentaires, de ne pas honorer la commande du client.

3.4 Lors de rappels de paiement, il sera facturé un supplément de CHF 20.- au premier et au deuxième rappel. Au troisième rappel, les frais seront de CHF 40.- en plus des frais de poursuite, et 5% d'intérêts seront facturés.

### 4. Réception des marchandises

4.1 A réception de la marchandise, il sera procédé de suite au contrôle du matériel (quantité et conformité) Des différences avec la commande sont à annoncer au plus tard 10 jours après la réception du matériel.

4.2 Si le matériel reçu n'est pas conforme ou incomplet, nous avons le choix entre le remplacer ou le compléter. Si cela n'est pas possible, ce sont les règles légales qui s'imposent (changement ou diminution de prix) Une compensation d'autres dégâts est exclue (Art.208 Abs.3 OR)

4.3 Lors de vente de matériel d'occasion, la garantie est totalement exclue.

4.4 Lors de matériel en consignation, la valeur de la consignation ne sera rendue qu'au retour du matériel consigné en l'état initial.

### 5. Garantie

5.1 En qualité d'entreprise commerciale, nous garantissons la marchandise livrée selon les garanties de nos fournisseurs (matériel sans défauts et fonctionnant correctement)

5.2 L'étendue de la garantie s'aligne sur celle de nos fournisseurs et comprend uniquement le remplacement ou le remboursement des pièces défectueuses. D'autres exigences (travail, frais de transport) sont exclues (voir 4.2)

### 6. Lieu de juridiction, tribunal compétent et droit applicable

6.1 Le lieu de juridiction est le siège du fournisseur. Seul le droit suisse est applicable. Le tribunal compétent est situé au siège de l'ETS Ersatzteilservice AG.

